



 **TSURUMI PUMP**<sup>®</sup>

**BUILT FOR WORK**<sup>®</sup>

CONTRACTOR PUMPS | ENGINE PUMPS | GENERATORS



## ELECTRIC SUBMERSIBLE PUMPS - Long Life by Design

### LB Features

- 1** TOP DISCHARGE, FLOW THRU DESIGN
- 2** MULTI-DIRECTIONAL DISCHARGE CONNECTOR: Can be configured for horizontal or vertical discharge. Providing for a more stable installation.
- 3** RUBBER CASING WITH LARGE ROUNDED CUT-WATERS: Resists wear and degradation of performance due to abrasive particles.
- 4** CABLE BOOT: Prevents kinking at cable entrance by extending bending radius.
- 5** ANTI-WICKING BLOCK: Prevents water incursion due to capillary wicking, should the power cable be damaged or the end submerged.
- 6** DUAL INSIDE MECHANICAL SEAL WITH SILICON CARBIDE FACES: Provides longer operational life of any seal available.
- 7** OIL LIFTER: Provides lubrication of the seal faces down to 1/3 of normal oil level and extends seal life by ten times—uses no additional power.

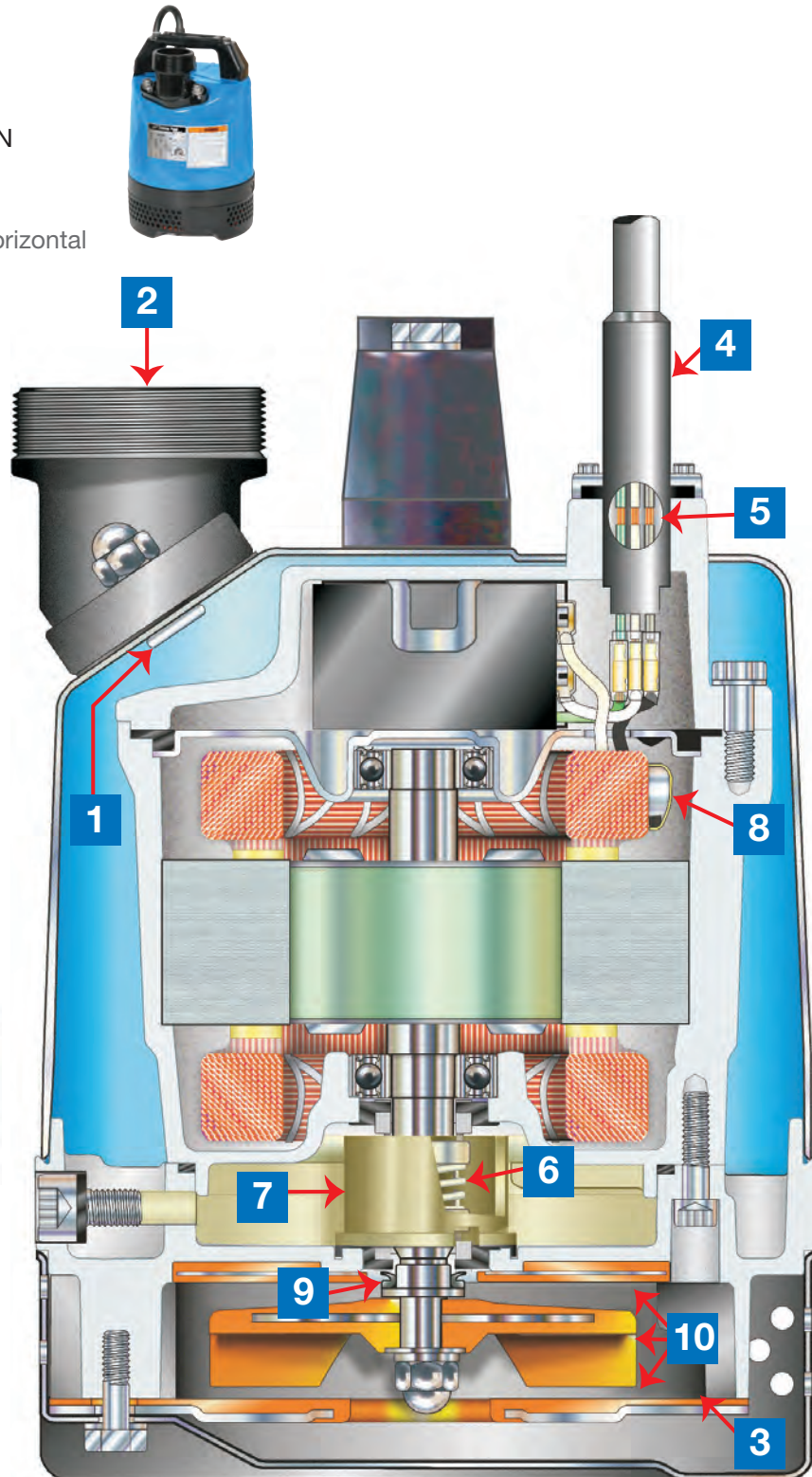

Featured Model LB-480

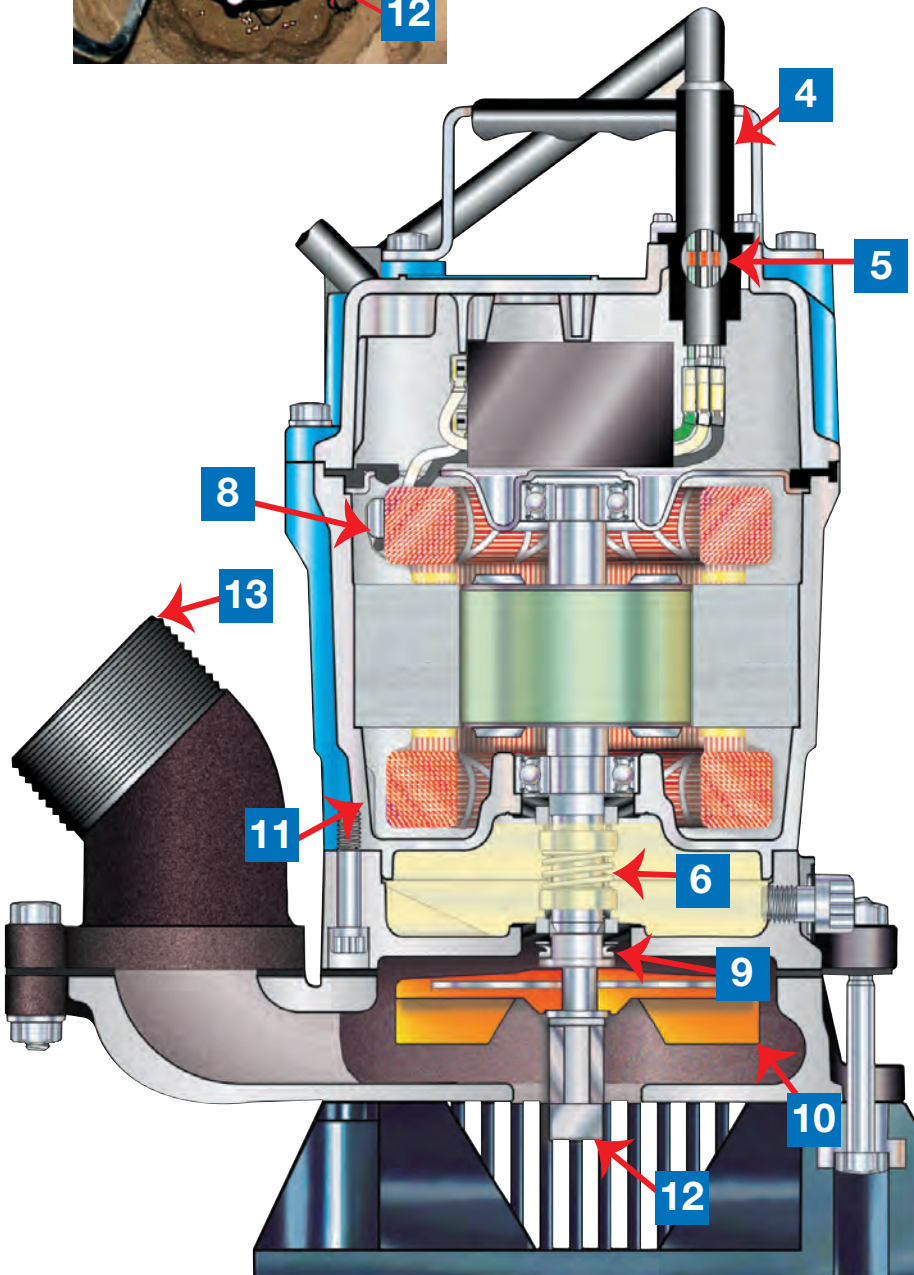
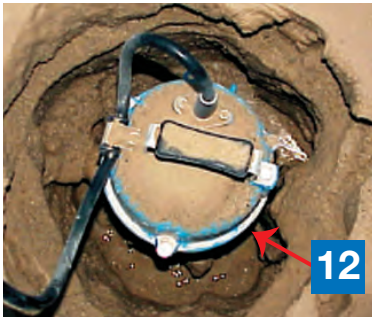

Featured Model HS2.4S

(Not all features available on every Tsurumi submersible pump)

**8** MINIATURE THERMAL MOTOR PROTECTOR: Protects against overheating & run-dry.

**9** V-RING SEAL PROTECTOR: Protects mechanical seal from abrasive particles.

**10** URETHANE, SEMI-VORTEX IMPELLER & WEAR PLATES: Resists wear by abrasive particles and does not depend on close tolerances to maintain pump performance.



Tsurumi Impeller polished, not worn by abrasive material.



Competitor Impeller is effectively worn out.

**11** COPPER WINDINGS WITH CLASS E INSULATION

### HS Features

**12** AGITATOR: Suspends sand and mud, allowing for sediment removal from sumps or basins.

**13** 45° ANGLED DISCHARGE CONNECTOR: Provides for a more stable installation for either vertical or horizontal discharge hose.

## GROUP PERFORMANCE RANGE

**Reliable and cost-effective pumps** enable Tsurumi to remain an industry leader in the rental and construction markets. Our customers know that while many pumps may look the same, only Tsurumi incorporates the most durable components into the final manufactured product.

### GROUP PERFORMANCE RANGE ELECTRIC SUBMERSIBLE PUMPS

Electric Submersible Pumps: Under 1HP

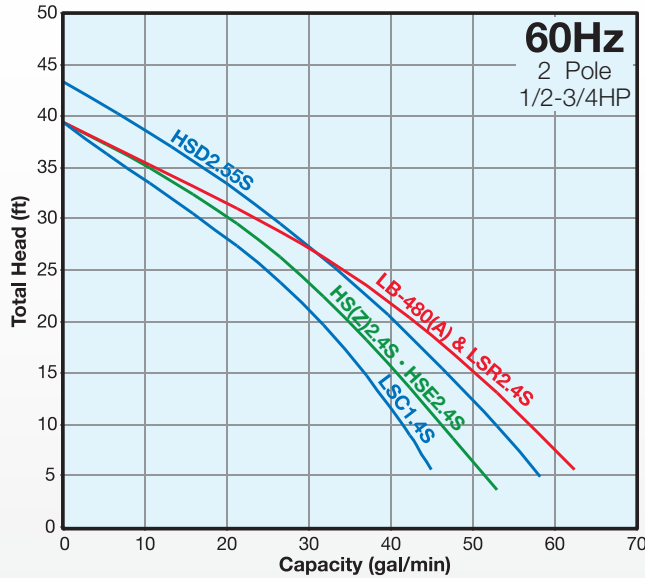

Electric Submersible Pumps: 1HP or more

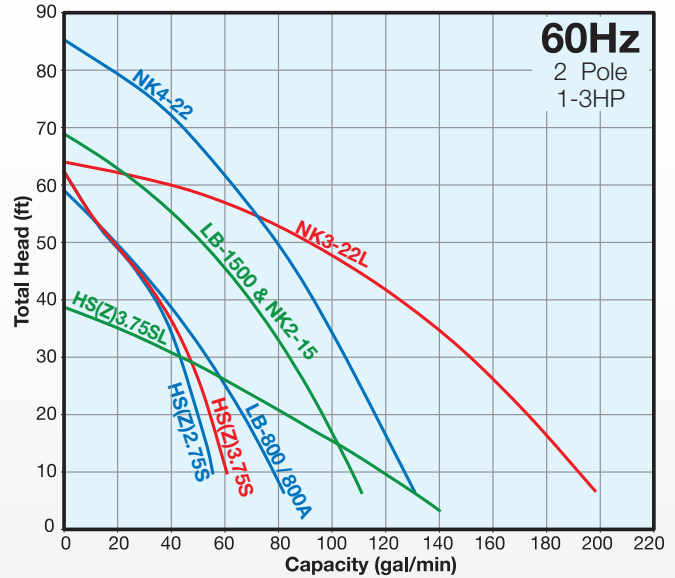

TM(A) Series • UT(Z) Series • 50SQ2-2.4S

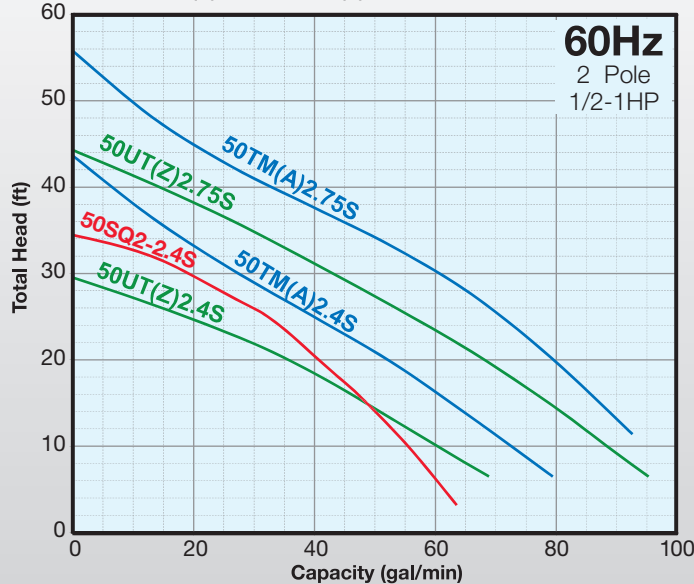

## LB-480 • LB-480A - DEWATERING PUMPS

**LB-480** Slimline design pump fits into 8" pipes. Powerful pumps built with durable materials in an easy handling design. Top discharge provides maximum motor cooling efficiency allowing continuous duty operation at low water levels and extended dry-run capability.

**LB-480A** features Relay Unit (Level Sensor) which incorporates low voltage, stainless steel probes, epoxy and rubber encapsulated timing relay, that turns the unit off when water is not present. It saves energy and extends the life of the motor and bearings!



LB-480



LB-480A

### LB-480 Features

- Urethane, Semi Vortex Impeller and Wear Plates for maximum durability and maintaining pump performance
- Dual Inside Mechanical Seal With SiC faces provides longer operational life
- Oil Lifter provides lubrication of the seal faces
- V-Ring Seal design protects mechanical seal from abrasive particles

Optional Accessories - See page 24-27

- TS-301 Float Switch for automatic operation
- Discharge hoses
- Quick connect fittings

### LB-480A Features

- No control panel or float switches required
- Performs like the non-automatic pump with no special float installation required
- Requires very small space to operate - only 8 3/4" diameter

### Technical Features of Automatic (A) Water Level Sensor

- Sensitive electrodes detect water to start pump operation even when foreign materials are present
- Internal 60-second timer eliminates frequent on/off operation in rough water to extend motor life
- Relay sensor completely molded in resin and covered by rubber case for protection against rough handling
- Jobsite tested for more than 30,000 on-off cycles without failure or damage

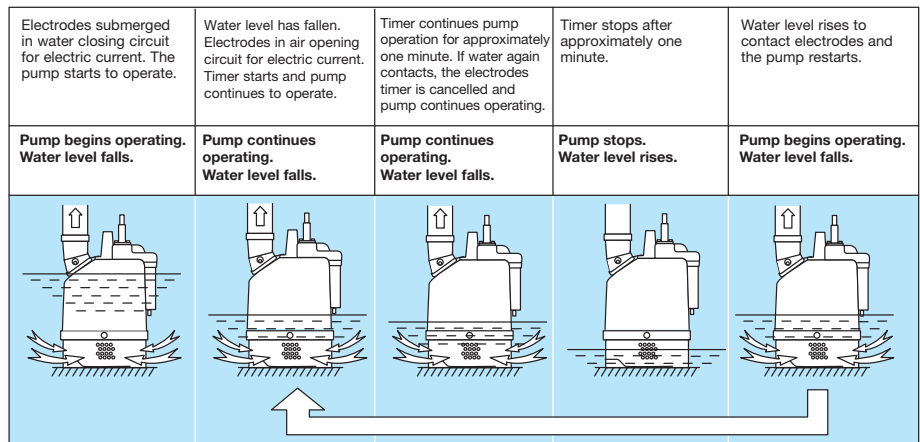
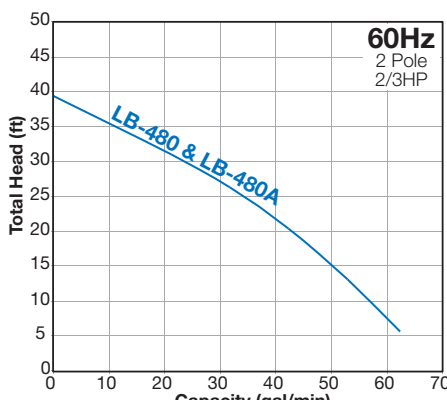

Certified by Intertek Testing Service to UL and CSA standards for submersible construction pumps.

Model	Motor Output (HP)	Phase	Discharge Bore (inch)	Cable Length (ft)	Dimension (inch)		Continuous Running Water Level (inch)	Shipping Weight (lbs.)
					Diameter	Heights		
LB-480	2/3	Single	2	32	7 11/16	11 1/4	2	28
LB-480A	2/3	Single	2	32	8 3/4	11 1/4	4 1/2*	29

\*Pump Starting Water Level

## LB-800 • LB-800A - DEWATERING PUMPS

**LB-800** Slimline design pumps fits into 8" pipes. Powerful pump built with durable materials in an easy handling design. Top discharge provides maximum motor cooling efficiency allowing continuous duty operation at low levels and extended dry-run capability.

**LB-800A** features Relay Unit (Automatic Water Level Sensor) which incorporates low voltage, stainless steel probes, epoxy and rubber encapsulated timing relay, that turns the unit off when water is not present. It saves energy and extends the life of the motor and bearings!



### LB-800 Features

- Designed to fit an 8" pipe
- Up to 59' shut off head
- Available in 230V single-phase
- Dual Inside Mechanical Seal With SiC faces provides longer operational life
- Oil Lifter provides lubrication of the seal faces

### Optional Accessories - See page 24-27

- Float Switch for automatic operation (TS-302 for 115V, TS-303 for 230V)
- Discharge hoses
- Quick connect fittings

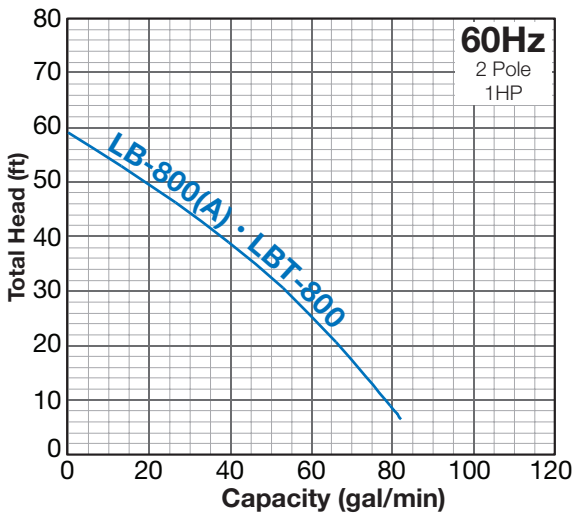

### LB-800A Features

- Up to 59' shut off head
- Dual Inside Mechanical Seal With SiC faces provides longer operational life
- Oil Lifter provides lubrication of the seal faces

### Technical Features of Automatic (A) Water Level Sensor

- Sensitive electrodes detect water to start pump cycling even when foreign materials are present
- Internal 60-second timer eliminates frequent on/off cycling in rough water to extend motor life
- Automatic water level sensor completely molded in resin and covered by rubber case for protection against rough handling.
- Jobsite tested for more than 30,000 on-off cycles without failure or damage

Certified by Intertek Testing Service to UL and CSA standards for submersible construction pumps.

Model	Motor Output (HP)	Phase	Discharge Bore (inch)	Cable Length (ft)	Dimension (inch)		Continuous Running Water Level (inch)	Shipping Weight (lbs.)
					Diameter	Height		
LB-800	1	Single	2	50	7 9/16	13 7/16	2	38
LB-800A	1	Single	2	50	8 3/4	13 7/16	6 3/4*	39

\*Pump Starting Water Level

## LB-1500 - DEWATERING PUMPS

LB-1500 Slimline design pumps fit into 8" pipes. Powerful pump built with durable materials in an easy handling design. Top discharge provides maximum motor cooling efficiency allowing continuous duty operation at low levels and extended dry-run capability.

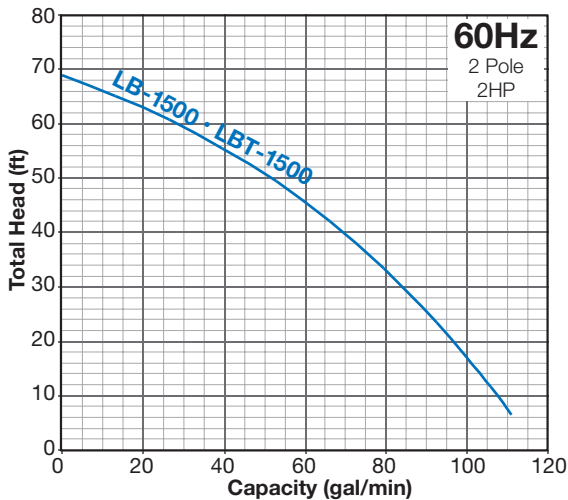

### LB-1500 Features

- Circle Thermal Motor Protector: Protects against overheating, over amperage & run-dry
- Anti-Wicking Block: Prevents water incursion due to capillary wicking should the power cable be damaged or the end submerged
- Oil Lifter: Lubricates the seal faces and extends seal life by ten times using no additional power, even when oil is down to 1/3 normal level.
- Dual inside mechanical seals with silicon carbide faces, (both top and bottom) running in an oil filled chamber provides for the most durable seal design available
- High Chrome Iron Semi-Open Impeller resists wear from abrasive particles
- Synthetic Rubber Pump Casting: For wear resistance and easy maintenance
- V-Ring System: Protects the shaft seals

### Optional Accessories - See page 24-27

- Float switch TS-304
- Discharge hoses
- Quick connect fittings
- Control panel
- 2" discharge

Certified by Intertek Testing Service to UL and CSA standards for submersible construction pumps.

Model	Motor Output (HP)	Phase	Discharge Bore (inch)	Cable Length (ft)	Dimension (inch)		Continuous Running Water Level (inch)	Shipping Weight (lbs.)
					Diameter	Height		
LB-1500	2	Single	3 (2)*	50	7 3/8	23 5/16	3 1/8	88

\*2" is optional

## HS • HSZ • HSE - TRASH PUMPS

**HS / HSZ / HSE Series TRASH PUMPS:** Durable trash pumps in two sizes—a 1HP 3-inch discharge and a 1/2HP 2-inch discharge. Both designed to pump water containing sand, solids and debris with minimal wear and clogging. HS2.4S / 2.75S / 3.75S / 3.75SL are manual trash pumps, and HSZ2.4S / 2.75S / 3.75S / 3.75SL are automatic trash pumps with integrated float switches. HSE2.4S is a HS2.4S trash pump with Automatic Water Level Sensor.

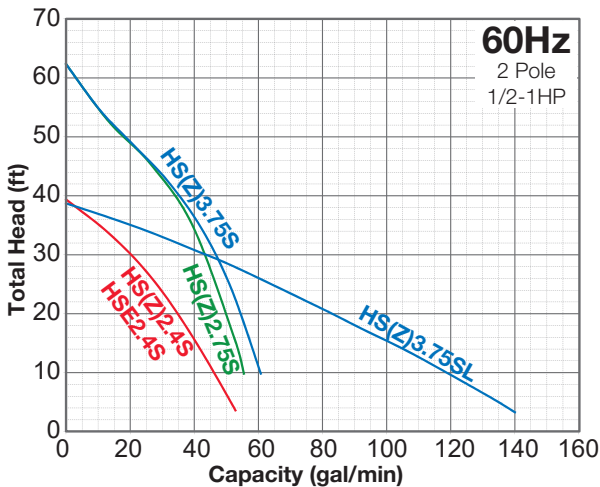

### HS • HSZ • HSE TRASH PUMP Features

- Built-in shaft mounted agitator suspends solids
- Urethane Semi Vortex Impeller for maximum durability and pump performance
- Dual Inside Mechanical Seal With SiC faces provides longest operational life
- Oil Lifter provides lubrication of the seal faces
- V-Ring Seal design protects mechanical seal from abrasive particles

### Technical Features of Automatic (E) Water Level Sensor\*

\* not for use in distilled or deionized water

- Sensitive electrodes detect water to start pump operation even when foreign materials are present
- Internal 60-second timer eliminates frequent on/off operation in rough water to extend motor life
- Automatic water level sensor completely molded in resin and covered by rubber case for protection against rough handling.
- Jobsite tested for more than 30,000 on-off cycles without failure or damage

### Optional Accessories - See page 24-27

- Vertical discharge coupling
- 2-inch NPT coupling available for HS(Z)3.75S
- Residue Kit (HS-RK) is available for HS2.4S / HSZ2.4S

HSZ2.4S / 2.75S / 3.75S(L) Pump Dimension Reference

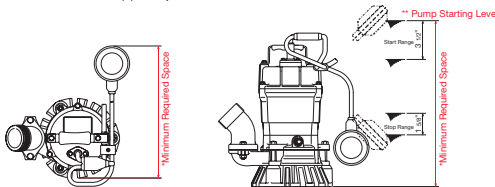

Certified by Intertek Testing Service to UL and CSA standards for submersible construction pumps.

Model	Motor Output (HP)	Phase	Discharge Bore (inch)	Cable Length (ft)	Dimension (inch)		Continuous Running Water Level (inch)	Float Start Level	Float Stop Level	Shipping Weight (lbs.)
					Diameter	Height				
HS2.4S	1/2	Single	2	20	10 1/16	12 15/16	3 1/2		N/A	30
HSZ2.4S	1/2	Single	2	20	13 1/2*	15 1/8*	15 1/8*	15 1/8	4 3/4	30
HSE2.4S	1/2	Single	2	32	10 1/16	14 1/8	6 1/2		N/A	30
HS2.75S	1	Single	2	32	11 7/16	15 5/16	3 1/2		N/A	47
HSZ2.75S	1	Single	2	32	13 1/2*	17 1/2*	17 1/2*	17 1/2	7 1/8	47
HS3.75S	1	Single	3*	32	12 7/16	15 5/16	3 1/2		N/A	50
HS3.75SL	1	Single	3	32	12 7/16	16 3/4	4 3/4		N/A	55
HSZ3.75S	1	Single	3*	32	13 1/2*	17 1/2*	17 1/2*	17 1/2	7 1/8	50
HSZ3.75SL	1	Single	3	32	15 3/4*	19 7/8*	19 7/8*	19 7/8	7 1/8	55

\*2" is optional

\*Minimum Required Space

\*Pump Starting Level



## HSD - EXTREME DUTY TRASH PUMP

EXTREME DUTY TRASH PUMP: Pumps water containing sand, solids and debris with minimal wear and clogging.

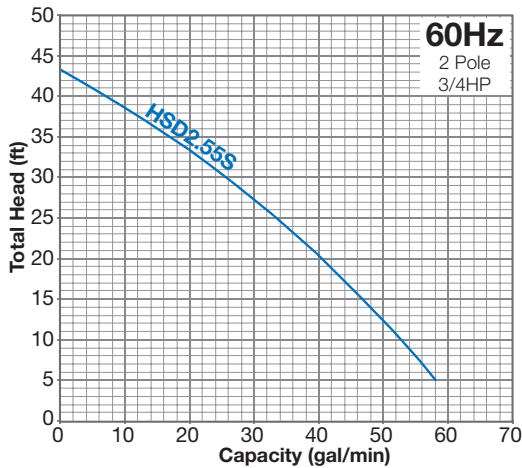

### HSD2.55S Trash Pump Features

- Anti-wicking block prevents water incursion
- Oil Lifter extends seal life by ten times
- Dual Inside Mechanical Seal with silicon carbide faces provides longer operational life of any seal available
- V-Ring Seal design protects mechanical seal from abrasive particles
- Built-in larger shaft mounted agitator suspends solids & eliminates clogging
- High Chromium Iron impeller & agitator
- Ductile iron pump casing
- 3/4 HP motor; larger than HS2.4S
- Easy pump end disassembly

### Optional Accessories - See page 24-27

- Float switch • Straight discharge
- Discharge hoses • Quick connect fittings

Certified by Intertek Testing Service to UL and CSA standards for submersible construction pumps.

Model	Motor Output (HP)	Phase	Discharge Bore (inch)	Cable Length (ft)	Dimension (inch)		Continuous Running Water Level (inch)	Shipping Weight (lbs.)
					Diameter	Heights		
HSD2.55S	3/4	Single	2	32	10 3/8	15 3/8	4 1/8	38

## NK - HEAVY DUTY HIGH HEAD PUMP

Heavy duty, single phase high head pumps capable of handling abrasive materials with minimal wear.

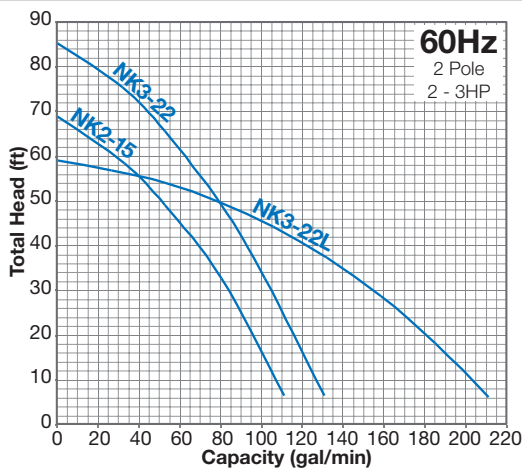

### NK2-15 • NK4-22 • NK3-22L Features

- Terminal board for voltage reconnect allows for change from 110V to 220V (NK2-15 only)
- NK2-15 & NK4-22: Semi Vortex Impeller and Synthetic Rubber Wear Plates for maximum durability and maintaining pump performance
- NK3-22L: Semi-Open Impeller
- Dual Inside Mechanical Seal With SiC faces provides longer operational life
- Oil Lifter provides lubrication of the seal faces
- V-Ring Seal design protects mechanical seal from abrasive particles

### Optional Accessories - See page 24-27

- TS-303 & TS-304 Float Switch for automatic operation
- Sand kit • 2" NPT coupling • Control panel
- Discharge hoses • Quick connect fittings

Certified by Intertek Testing Service to UL and CSA standards for submersible construction pumps.

Model	Motor Output (HP)	Phase	Discharge Bore (inch)	Cable Length (ft)	Dimension (inch)		Continuous Running Water Level (inch)	Shipping Weight (lbs.)
					Diameter	Heights		
NK2-15	2	Single	3*	32	9 7/16	24 1/2	3 1/4	80
NK4-22	3	Single	3*	32	9 7/16	24 3/16	3 1/4	81
NK3-22L	3	Single	3*	32	9 1/4	26 1/2	4 3/4	90

## LSC • LSR - GROUND DRAINAGE PUMP

**LSC DRAINAGE PUMP:** Original residue dewatering pump; able to pump down to the floor, even the smallest puddle can be pumped dry. LSC drainage pump is the best for complete drainage of flat surfaces where a sump is not available.

**LSR DRAINAGE PUMP:** Pump holds suction for drainage to 0.4 inch water level.



LSC1.4S



LSR2.4S

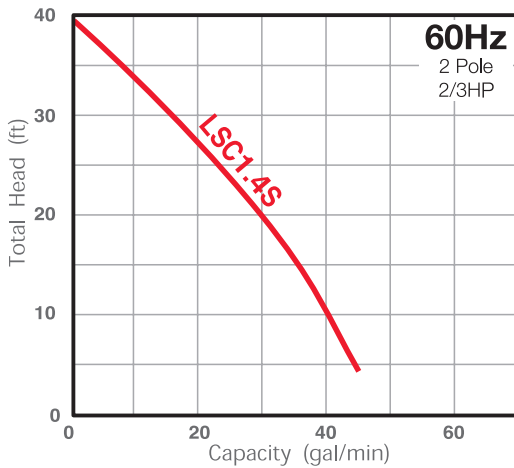

### LSC1.4S Features

- Prime pump through discharge outlet for start up at any water level
- Internal check valve holds prime and prohibits back flow through pump when stopped
- Urethane, Semi Vortex Impeller and Wear Plates for maximum durability and maintaining pump performance
- Dual Inside Mechanical Seal With SiC faces provides longer operational life
- Oil Lifter provides lubrication of the seal faces
- V-Ring Seal protects mechanical seal from abrasive particles

### Optional Accessories - See page 24-27

- SLS-LSC20 Automatic operation surface level switch
- 2" Discharge
- Discharge hoses
- Quick connect fittings

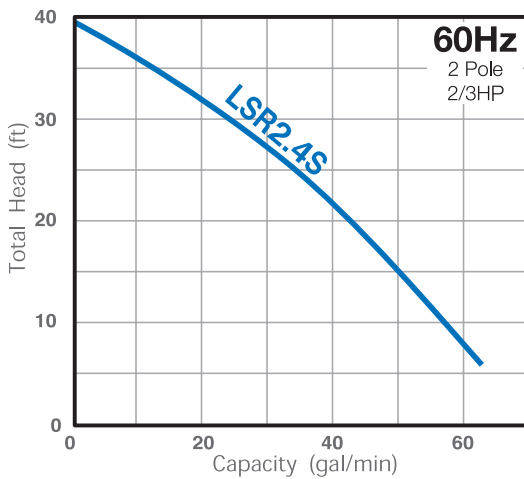

### LSR2.4S Features

- Urethane, Semi Vortex Impeller and Wear Plates for maximum durability and maintaining pump performance
- Dual Inside Mechanical Seal With SiC faces provides longer operational life
- Oil Lifter provides lubrication of the seal faces
- V-Ring Seal protects mechanical seal from abrasive particles

### Optional Accessories - See page 24-27

- SLS-LSR32 Automatic operation surface level switch
- Discharge hoses
- Quick connect fittings

Certified by Intertek Testing Service to UL and CSA standards for submersible construction pumps.

Model	Motor Output (HP)	Phase	Discharge Bore (inch)	Cable Length (ft)	Dimension (inch)		Continuous Running Water Level (inch)	Shipping Weight (lbs.)
					Diameter	Heights		
LSC1.4S	2/3	Single	3/4	20	7 11/16	12 7/16	0.04	29

Certified by Intertek Testing Service to UL and CSA standards for submersible construction pumps.

Model	Motor Output (HP)	Phase	Discharge Bore (inch)	Cable Length (ft)	Dimension (inch)		Continuous Running Water Level (inch)	Shipping Weight (lbs.)
					Diameter	Heights		
LSR2.4S	2/3	Single	2	32	8 1/4	11 3/8	0.2	27

## F-13 • L4000 - UTILITY PUMP

**F-13:** Oil free economical submersible pump for clean, surface water applications. Available ready to plug-in, with built-in level control, 1 1/4" or 3/4" NPT discharge.

**L4000:** Designed to meet and exceed the tough demands of commercial and recreational duty. 12VDC operation.

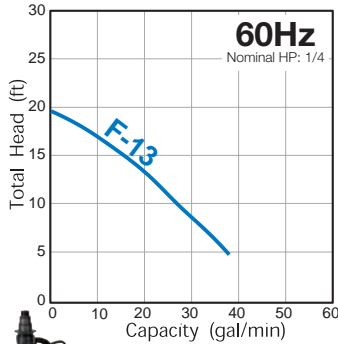

F-13

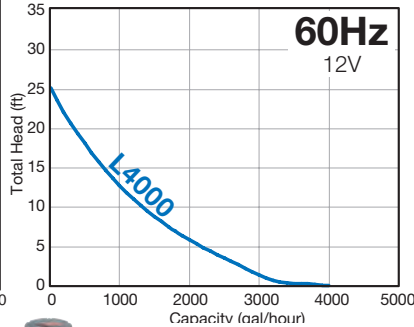

L4000

### F-13 Features

- Completely oil free air filled motor protected by 3 oil seals
- Built-in thermal motor protector
- Incorporates a check valve built into the discharge
- Pump can be operated either manual or automatic
- 1-1/4" NPT discharge with garden hose adaptor (3/4")
- Easy grip handle design

### L4000 Features

- 1 1/2" and 2" Discharge Ports
- Liquid Cooled Motor
- Universal Mounting Base
- Double-Ball Bearing
- Mechanical Shaft Seal
- Salt Water Tough
- 12VDC Motor

Model	Max. Capacity (GPM)	Max. Head (ft)	Discharge Size (in) - Internal Thread	Nominal HP	RPM	Rated Current at 115V (amps)	Standard Cable Length (ft)	Shipping Weight (lbs.)
F-13	38	19	1 1/4 or 3/4	1/4	3450	4.2	20	11

Model	Max. Capacity (GPH)	Max. Head (ft.)	Body Material	Discharge Size (in.) & Parts Material	Impeller	Shaft Seal	Voltage (V) /Amps	Standard Cable Length (ft.)	Shipping Weight (lbs.)
L-4000	4000	25	High Impact ABS Thermo-Plastic	1-1/2 & 2 Polypropylene	Glass/Nylon Composite	Mechanical (Carbon/Ceramic)	12 / 19.5	6	6

## UT • UTZ - SINGLE PHASE CAST IRON SUBMERSIBLE SEWAGE PUMP

UT • UTZ Series pumps are compact economical cast iron pumps that is designed for a wide range of applications.

50UT2.4S



50UT2.4S

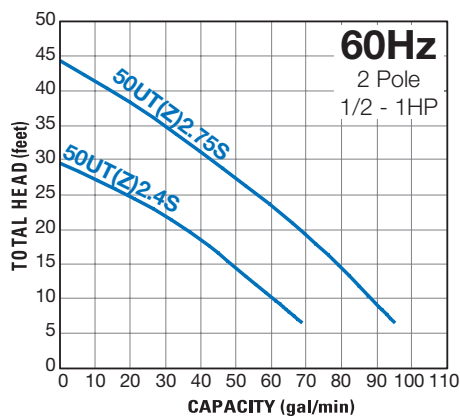

### UT • UTZ Series Features

- LARGE DIAMETER PASSAGE - UT & UTZ pumps have a large passage (1.4") that makes it ideal for liquid containing various solids
- Heat resistant Silicon Carbide Mechanical Seals assist in cooling in the event of run-dry situations
- Motor protector protects against overheat and run-dry
- Semi-vortex, PPO resin impeller passes solids and stringy material without clogging
- Available in both manual operation (UT) and automatic operation equipped with a float (UTZ)

Certified by Intertek Testing Service to UL and CSA standards for submersible construction pumps.

Model	Motor Output (HP)	Phase	Discharge Bore (inch)	Cable Length (ft)	Dimension (inch)		Continuous Running Water Level (inch)	Shipping Weight (lbs.)
					Diameter	Heights		
50UT2.4S	1/2	Single	2	20	9 1/2	11 3/4	11 3/4	35
50UT2.4S	1/2	Single	2	20	11 5/8	15 3/4	15 3/4	35
50UT2.75S	1	Single	2	32	9 1/2	16	13 3/4	46
50UT2.75S	1	Single	2	32	11 5/8	18	18	46

## SQ - 50SQ2-2.4S SINGLE PHASE PORTABLE CORROSION-RESISTANT PUMP

The SQ pump features a top discharge, flow-thru design with forced motor cooling that enables extended running at low water level. In addition, the SQ pump fits into an 8-inch pipe.

50SQ2-2.4S

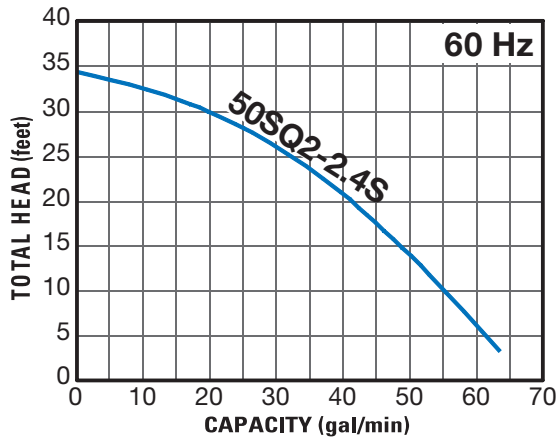

### 50SQ2-2.4S Features

- Constructed of a combination of 304 and 316 stainless steel materials, Nitrile Butadiene Rubber and special resin to stand up to rust and corrosion, and sport a new structural design that makes them even lighter and easier to carry
- Non-toxic white mineral oil used to lubricate mechanical seals
- Motor protector protects against overheating and run-dry
- Designed to fit into an 8-inch pipe

Model	Motor Output (HP)	Phase	Discharge Bore (inch)	Cable Length (ft)	Dimension (inch)		Continuous Running Water Level (inch)	Shipping Weight (lbs.)
					Diameter	Heights		
50SQ2-2.4S	1/2	Single	2	32	7 1/16	14 7/16	2 3/8	27

## TM • TMA - SINGLE PHASE TITANIUM SEAWATER PUMP

Titanium construction, semi-vortex solids handling impeller. Ideal for saltwater and chemical applications.

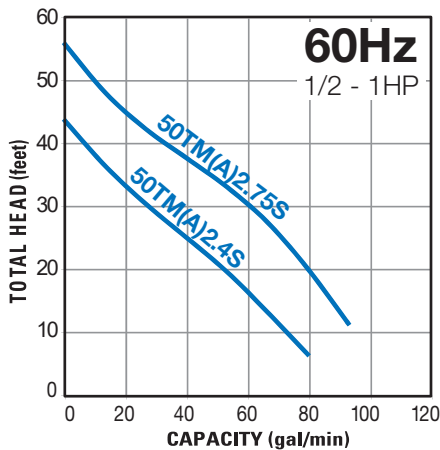

### TM / TMA Series Features

- Titanium and FRP components increases corrosion resistance in a wide variety of applications
- Ideal use for salt water, site drainage and bilge pumps
- Available in manual operation (TM) and automatic operation (TMA)

Certified by Intertek Testing Service to UL and CSA standards for submersible construction pumps.

Model	Motor Output (HP)	Phase	Discharge Bore (inch)	Cable Length (ft)	Dimension (inch)		Continuous Running Water Level (inch)	Shipping Weight (lbs.)
					Diameter	Heights		
50TM2.4S	1/2	Single	2	32	9 15/16	14 3/16	12 3/4	20
50TMA2.4S	1/2	Single	2	32	13	14 3/4	23 7/8*	21
50TM2.75S	1	Single	2	32	9 15/16	14 15/16	13 5/8	25
50TMA2.75S	1	Single	2	32	13	15 1/2	24 5/8*	26

\* Pump Starting Water Level

**ENGINE DRIVEN PUMPS CENTRIFUGAL PUMP • TRASH PUMP • TRAILER MOUNTED**

**TSURUMI Engine Powered Pumps** are constructed for maximum durability in a compact, easy handling design. Utilizing superior features and materials, Tsurumi provides an affordable, high value pump line designed to withstand your tough dewatering applications.

High chrome impeller, cast iron volute casing with stainless steel wear plate provides **increased durability and decreased maintenance** (Trash pumps only).

Durable Rolled-Steel frame provides for a safe, stable platform, **protects pump/engine during operation and transport**, and allows for easy handling.

Silicon Carbide mechanical seal **provides longer life**. Silicon Carbide's high uniform hardness and high density makes it an extremely abrasion resistant material.



Oil Alert System **automatically shuts the engine down** if the oil level falls below the safe operating level.

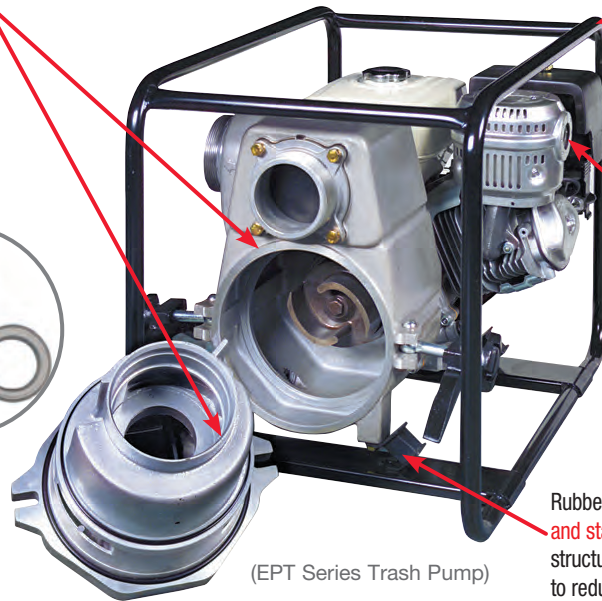

Heavy-duty Honda gas engine **delivers high power** from a compact, reliable design.

Rubber Vibration Isolators **ensure safe and stable operation**, reduce vibration of structural parts and support the pump casing to reduce hose or pipe strain.

(EPT Series Trash Pump)

**TE SERIES GAS ENGINE CENTRIFUGAL PUMPS**



**TE3-50HA**  
2" Centrifugal Pump  
Powered by Honda



**TE3-80HA**  
3" Centrifugal Pump  
Powered by Honda



**TE2-100HA**  
4" Centrifugal Pump  
Powered by Honda



**TE2-25H**  
1" Compact Centrifugal Pump  
Powered by Honda

**EPT SERIES GAS ENGINE TRASH PUMPS**



**EPT3-50HA**  
2" Trash Pump  
Powered by Honda



**EPT3-80HA**  
3" Trash Pump  
Powered by Honda



**EPT3-100HA**  
4" Trash Pump  
Powered by Honda

**THP HIGH PRESSURE PUMP**



**THP-4070HA**  
1" / 1.5" High Pressure Pump  
Powered by Honda

## TE SERIES - GAS ENGINE CENTRIFUGAL PUMP

Tsurumi TE Series centrifugal pumps are powerful & lightweight pumps powered by heavy-duty **Honda GX** engine. Available in 1", 2", 3" and 4" NPT coupling suction sizes.



TE2-25H



TE3-50HA



TE3-80HA



TE2-100HA

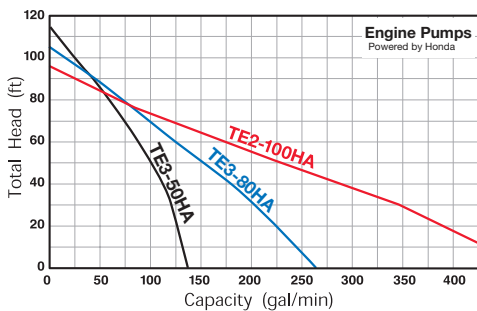
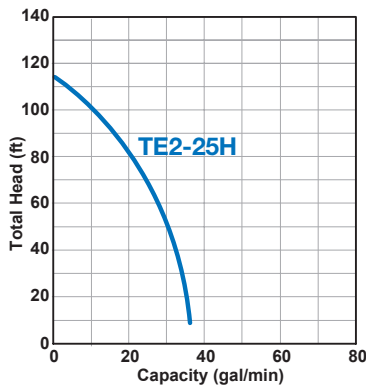

### TE Series Features

- Heavy-duty Honda gas engine with oil sensor and Silicon Carbide mechanical seal provides longer life
- Cast Iron impeller and volute casing
- Durable Rolled-Steel frame provides pump/engine with maximum protection, perfect ease of handling or transport, and safe operation
- Rubber mounts on the pump and the frame
- Suction strainer included (TE2-25H)
- 1", 2" and 3" models are light enough for parcel shipment

Optional Accessories - See page 24-27

Hose Kit, Hoses, Hose accessories, Wheel Kit



Model	Discharge / Suction Size	Engine	Max. Output (hp/rpm)	Dimensions (inches)			Shipping Weight (lbs.)
				Length	Width	Height	
TE2-25HA	1" NPSH Coupling	Honda GX-25	1.1 / 2220	9	14	13	16
TE3-50HA	2" NPT Coupling	Honda GX-120	4.0 / 3600	18 1/2	14 5/8	17 1/8	54
TE3-80HA	3" NPT Coupling	Honda GX-160	5.5 / 3600	20 1/2	16 1/2	18 1/8	64
TE2-100HA	4" NPT Coupling	Honda GX-240	8.0 / 3600	25	18	23 1/2	109

## EPT SERIES - GAS ENGINE TRASH PUMP

**Tsurumi EPT Series** are designed with oversized pump casing, and a cleanout door which can be removed from the pump casing without having to remove the suction hose. Powered by heavy-duty Honda GX Gas engines and Vanguard Engines



EPT3-50HA



EPT3-80HA



EPT3-100HA

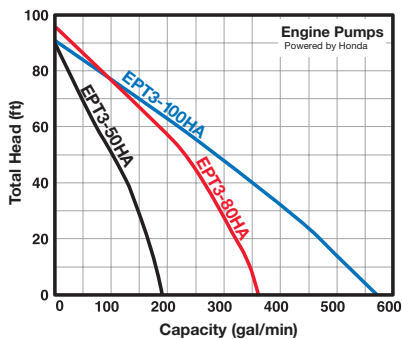

### EPT Series Features

- Heavy-duty Honda gas engine with oil sensor delivers high power from a compact, reliable design. Silicon Carbide mechanical seal provides longer life
- High Chrome impeller, Cast Iron volute casing plus Stainless Steel wear plate promise increased durability and decreased maintenance
- Pump/engine set mounted to cage frame on Rubber Vibration Cushions to buffer stress and wear
- Durable Rolled-Steel frame provides pump/engine with maximum protection, perfect ease of handling or transport and safe operation
- Wheel Kit for easy transportation available with all trash pumps as an optional accessory

Optional Accessories - See page 24-27  
 Hose Kit, Hoses, Hose accessories, Wheel Kit

EPT3-100HA

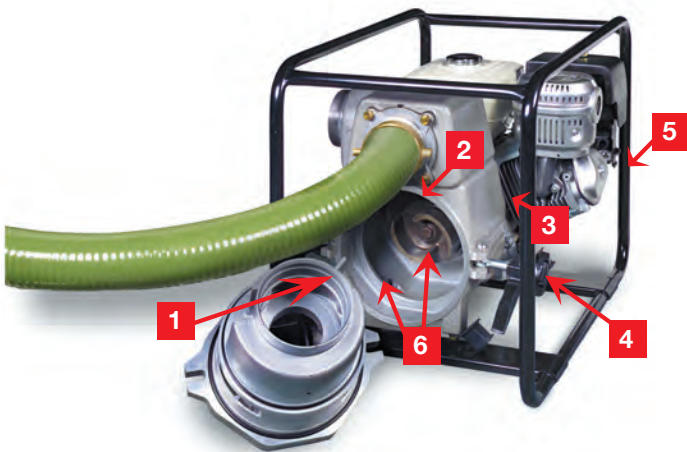

### Tsurumi EPT Series Engine Trash Pump

- 1 The clean-out door can be disassembled easily without taking off suction hose.
- 2 Designed with larger pump casing.
- 3 Heavy-duty Honda gas engine.
- 4 Mounted to cage frame on Rubber Vibration Cushions.
- 5 Durable rolled-steel frame.
- 6 High Chrome impeller, cast Iron volute casing, stainless steel wear plate

Model	Discharge / Suction Size	Engine	Max. Output (hp/rpm)	Dimensions (inches)			Shipping Weight (lbs.)
				Length	Width	Height	
EPT3-50HA	2" NPT Coupling	Honda GX-160	5.5 / 3600	23 1/4	18 1/4	17 3/8	92
EPT3-80HA	3" NPT Coupling	Honda GX-240	8.0 / 3600	27 1/2	20 1/8	25 5/8	140
EPT3-100HA	4" NPT Coupling	Honda GX-340	14.0 / 3600	30 1/8	20 1/8	26	157

## THP - GAS ENGINE HIGH PRESSURE PUMP

High pressure and high performance: A pump for sprinkling, irrigation and fire protection.

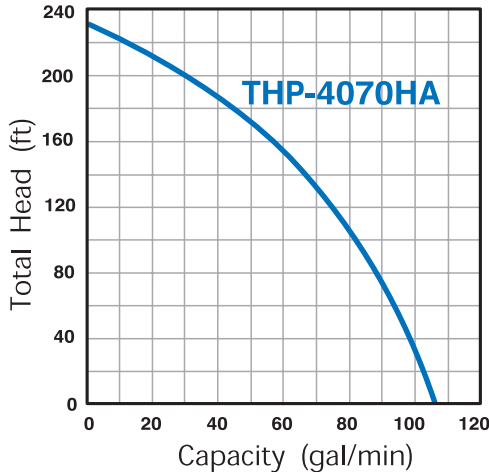

### THP Series Features

- Heavy-duty Honda gas engine with oil sensor and Silicon Carbide mechanical seal provides longer life
- Maximum pressure of 100 PSI for high pressure applications
- Versatile 3-way discharge allows pump to run up to three discharge lines simultaneously
- Two 1" couplings and one 1 1/2" coupling
- High head, closed impeller and cast iron volute casing deliver high performance and long wear life

Optional Accessories - See page 24-27

- 1" or 1.5" Lexan nozzle
- 1" or 1.5" Mill hose
- 1" or 1.5" Suction hose

Model	Discharge Size	Suction Size	Engine	Max. Output (hp/rpm)	Dimensions (inches)			Shipping Weight (lbs.)
					Length	Width	Height	
THP-4070HA	1" x 2, 1.5" x 1 NPSH Coupling	1.5" NPSH Coupling	Honda GX-160	5.5 / 3600	21	16	18	62

## TD6 DIAPHRAGM PUMP - GAS & ELECTRIC

Capable of continuous dry operation for seepage dewatering. Handles sand, mud and sludge. Both HONDA GX120 engine driven (TD6 Series) and electric motor (TDE6 Series) diaphragm pumps are available.

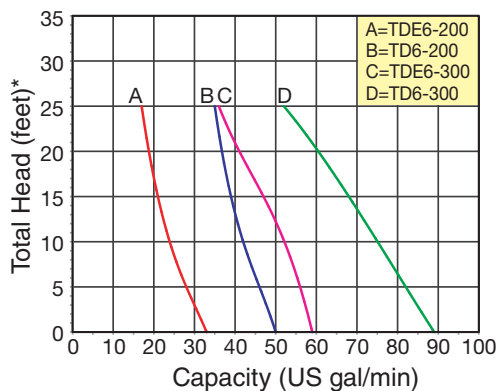

(\*) Convert to psi, divide by 2.31 Liquid - Water specific gravity 1.0

### TD6 / TDE6 Diaphragm Pumps Features powered by Honda

- Sand cast aluminum construction for portability and durability
- Thermoplastic rubber diaphragm
- 2" or 3" NPT suction and discharge size
- 1-5/8" diameter solids handling capability
- Modular component design permits easy maintenance and cleanout
- Gas engine model: Honda GX120 (TD6) / Electric motor model (TDE6)
- Delivers up to 88 GPM (TD6-300) / 59 GPM (TDE6-300)
- 90° Rotatable base on all models
- Maximum temperature 180°F

Optional Accessories - See page 24-27

- Suction hose kits
- Discharge hose kits

Model	Discharge / Suction Size (inches)	Engine	Max. Output (hp/rpm)	Dimensions (inches)			Shipping Weight (lbs.)
				Length	Width	Height	
TD6-200	2" NPT Coupling	Honda GX-120	4 / 3600	43	20	23	165
TD6-300	3" NPT Coupling	Honda GX-120	4 / 3600	43	26	23	175
TDE6-200	2" NPT Coupling	N/A	4 / 1725	44	20	23	175
TDE6-300	3" NPT Coupling	N/A	4 / 1725	44	26	23	185



## EPT5 MOUNTED TRASH PUMP

Industrial duty 6-inch trash pump: Powered by Honda gas engine / Kohler diesel engine.



### EPT5-150HA (Honda Gas Engine)

### EPT5-150KD (Diesel Engine) Trash Pump Features

- Cast Aluminum Casing and Adapter
- Cast Iron Wear Plate, Volute and Manifold
- Stainless Steel Impeller
- Silicon Carbide Mechanical Seal and Buna O-Rings and Flapper / Check Valve
- 6" NPT Port Size
- Self Priming to 20ft
- Available with Honda GX670 Gas Engine or a Diesel Engine (Final Tier 4)
- Solids Handling to 3" Diameter
- Unique Slide Mechanism permits complete service of pump without removing hoses or removing pump components from trailer
- Includes Seal Wash Feature for extended seal life
- 12 VDC Electric Start; Digital Tachometer / hourmeter included
- U.S. D.O.T. Approved Trailer - See your state and local codes for registration

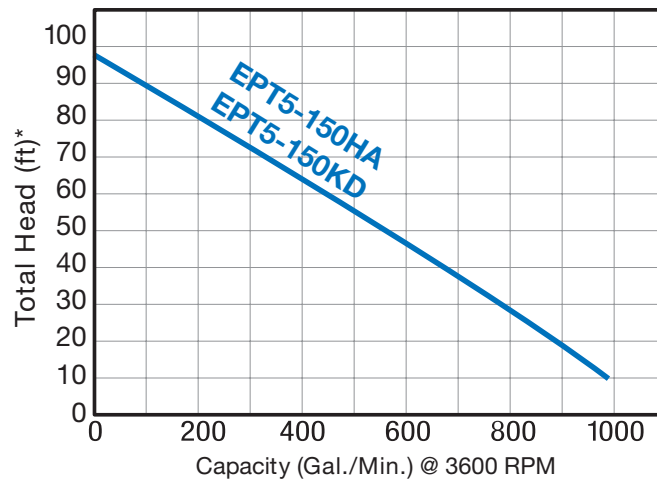

Model	Discharge Suction Size (inches)	Engine Type	Engine	Max. Output (hp/rpm)	Dimensions (inches)			Shipping Weight (lbs.)
					Length	Width	Height	
EPT5-150HA	6" NPT Coupling	Unleaded Gasoline	Honda GX-670	24.0 / 3600	99	48	60	1125
EPT5-150KD	6" NPT Coupling	Diesel	Call for more Info	23.4 / 3600	99	48	60	1250

# SPECIFICATIONS - SINGLE PHASE PUMPS: LB • HS(Z) • HSE • HSD

	LB-480	LB-480A	LB-800	LB-800A	LB-1500	HS2.4S	HSZ2.4S	HS2.75S	HSZ2.75S	HS3.75S	HSZ3.75S	HS3.75SL	HSZ3.75SL	HSE2.4S	HSD2.55S		
	2" Dewatering Pump	2" Auto Dewatering Pump	2" Slimline Pump	2" Auto Slimline Pump	3" Slimline Pump	2" Sand/Solid Trash Pump	2" Auto Trash Pump	2" Sand/Solid Trash Pump	2" Auto Trash Pump	3" Sand/Solids Trash Pump	3" Auto Trash Pump	3" Sand/Solids Trash Pump	3" Auto Trash Pump	2" Trash Pump with Auto Water Level Sensor	2" Extreme Durable Sand Pump		
<b>FLUID</b>	Max. Capacity (GPM)	63		82		111		53		55		61		132			
	Max. Head (ft.)	40		59		69		39		62		62		36			
	Solid Diameter (in.)	0.236					0.276					0.393					
<b>PUMP</b>	Impeller	Semi-Vortex			Semi-Open		Semi-Vortex										
	Impeller Material	Urethane Rubber			High Chrome		Urethane Rubber									High Chrome	
	Casing Material	Ethylene Propylene Rubber	Butadiene Rubber & Natural Rubber			Butadiene Rubber & Natural Rubber & Steel	Gray Iron Casing									Ductile Iron Casing	
	Wear Plate Material	Urethane Rubber			Natural Rubber		Integral Part of Casing										
	Shaft Seal - Type / Material	Double Inside Mechanical Seal with Silicon Carbide faces on lower seals and Carbon Ceramic Faces on upper seals															
	Seal Lubricant - Type	SAE 10W/20W or Turbine Oil (ISO VG32)															
	Seal Lubricant Amount (oz.)	5.2			12.5		5.4										
	Seal Protection	V-Ring and Oil Lifter															
	Discharge Connection	2" MNPT Coupling			3" MNPT Coupling (2" is optional)		2" MNPT Coupling		2" MNPT Coupling		3" MNPT Coupling (2" optional)		3" MNPT Coupling		2" MNPT Coupling		
	<b>MOTOR</b>	Motor Output (HP)	2/3		1		2		1/2		1		1		1		1/2
Phase		Single Phase															
Voltage (V)		115 or 230		115		115 or 230		115 or 230		115		115 or 230		115		115	
Amperage - Rated Current		5.9 (115V) 3.0 (230V)	5.9 (115V)	10.5 (115V) 5.2 (230V)	26.2 (115V) 13.2 (230V)	5.2 (115V) 2.7 (230V)	10.0 (115V)		9.7 (115V) 4.9 (230V)		5.2 (115V) 7.3 (115V)		12.4 (115V) 19.0 (115V)				
Amperage - Starting Current		12.4 (115V) 5.9 (230V)	12.4 (115V)	20.6 (115V) 12.6 (230V)	112 (115V) 56 (230V)	12.4 (115V) 5.9 (230V)	29.7 (115V)		29.7 (115V) 18.5 (230V)		12.4 (115V) 19.0 (115V)						
Type		Continuous Duty, Air Filled, 3600 RPM, 60Hz															
Bearings		Double shielded, permanently lubricated, high-temp C3 with B-10 life of 60,000 hours															
Insulation Class		E			B		E										
Motor Protection (Built-In)		Miniature Protector		Circle Thermal Protector			Miniature Protector		Circle Thermal Protector				Miniature Protector		Circle Thermal Protector		
Plug Configuration (NEMA)		5-15P (115V) No Plug (230V)		5-15P (115V) No Plug (230V)		No Plug		5-15P (115V) No Plug (230V)		5-15P (115V) No Plug (230V)							
Cable - # of Conductors x AWG	3C x 16AWG		3C x 14AWG		3C x 12AWG (115V) 3C x 12AWG (230V)		3C x 16AWG		3C x 14AWG				3C x 16AWG				
Standard Cable Length (ft.)	32		50			20		32				32		32			
Max. Cable Length (ft.)	110 (115V) 420 (230V)	110 (115V)	100 (115V) 400 (230V)	70 (115V) 160 (230V)	125 (115V) 460 (230V)	100 (115V) 430 (230V)		120 (115V) 90 (115V)									
Recommended Generator Capacity (watts)	1230		2240		7320		1230		3190				1230		2100		
Optional Float Switch	TS-301	N/A	TS-302 (115V) TS-303 (230V)	N/A	TS-303 (230V operation only)	TS-301 (115V)	N/A	TS-302	N/A	TS-302	N/A	TS-302	N/A	N/A	TS-301		
<b>DIMENSION</b>	Diameter (in.)	7 11/16	8 3/4	7 9/16	8 3/4	7 3/8	10 1/16	13 1/2	11 7/16	13 1/2	12 7/16	13 1/2	12 7/16	15 3/4	10 1/16	10 3/8	
	Height (in.)	11 1/4	11 1/4	13 7/16	13 7/16	23 5/16	12 15/16	15 1/8	15 5/16	17 1/2	15 5/16	17 1/2	16 3/4	19 7/8	14 1/8	15 3/8	
	Continuous Running Water Level (C.W.L.) (in.)	2	4 1/2 (Pump Starting Water Level)	2	6 3/4 (Pump Starting Water Level)	3 1/8	3 1/2	15 1/8 (Pump Starting Water Level)	3 1/2	17 1/2 (Pump Starting Water Level)	3 1/2	17 1/2 (Pump Starting Water Level)	4 3/4	19 7/8 (Pump Starting Water Level)	6 1/2 (Pump Starting Water Level)	4 1/8	
	Shipping Weight (lbs.)	28	29	38	39	88	30	30	47	47	50	50	55	55	30	38	

# SPECIFICATIONS - SINGLE PHASE PUMPS: LSR • LSC • NK • SQ • UT(Z) • TM(A)

		LSR2.4S	LSC1.4S	NK2-15	NK4-22	NK3-22L	50SQ2-2.4S	50UT2.4S	50UT2.4S	50UT2.75S	50UT2.75S	50TM2.4S	50TM2.4S	50TM2.75S	50TM2.75S		
		2" Ground Level Pump	1" Floor Level Pump	3" Heavy Duty High Head Pump	3" Heavy Duty High Head Pump	3" Heavy Duty High Flow Pump	2" Portable Stainless Steel Pump	2" Cast Iron Submersible Pump	2" Cast Iron Auto Submersible Pump	2" Cast Iron Submersible Pump	2" Cast Iron Auto Submersible Pump	2" Manual Titanium Pump	2" Auto Titanium Pump	2" Manual Titanium Pump	2" Auto Titanium Pump		
<b>FLUID</b>	Max. Capacity (GPM)	63	45	111	131	211	63	69		95		79		92			
	Max. Head (ft.)	40	39	69	85	59	34	29.5		44		44		56			
<b>PUMP</b>	Solid Diameter (in.)	0.236		0.334			0.236	1.4				0.394					
	Impeller	Semi-Vortex				Semi-Open	Semi-Vortex	Semi-Vortex				Semi-Vortex					
	Impeller Material	Urethane Rubber		Ductile Iron Casing		High Chrome	304 Stainless Steel	PPO Plastic				PPO Plastic					
	Casing Material	Ethylene Propylene Rubber				Cast Iron	304 Stainless Steel	Cast Iron				ABS Plastic					
	Wear Plate Material	Urethane Rubber		Integral Part of Casing		Ductile Iron Casing	304 Stainless Steel	---				---					
	Shaft Seal - Type / Material	Double Inside Mechanical Seal with Silicon Carbide faces on lower seals and Carbon Ceramic Faces on upper seals															
	Seal Lubricant - Type	SAE 10W/20W or Turbine Oil (ISO VG32)										White Mineral Oil (ISO VG32)					
	Seal Lubricant Amount (oz.)	5.1	5.2	9.1			5.4	5.4	7.8		8.1						
	Seal Protection	V-Ring and Oil Lifter										Oil Lifter					
	Discharge Connection	2" MNPT Coupling	3/4" MNPT Coupling	3" MNPT Coupling (2" optional)			2" FNPT Flange	2" MNPT Coupling				2" FNPT Flange					
<b>MOTOR</b>	Motor Output (HP)	2/3		2	3		1/2	1/2	1		1/2	1					
	Phase	Single Phase															
	Voltage (V)	115		110 or 220		230	220	115 or 230		115		115 or 230		115 or 230			
	Amperage - Rated Current	5.9 (115V)		23.0 (110V) 11.5 (220V)		11.7	13	6.5 (115V) 3.4 (230V)		5.7 (115V)		9.9 (115V) 5.2 (230V)		5.8 (115V) 2.9(230V)		9.2 (115V) 4.6 (230V)	
	Amperage - Starting Current	12.4 (115V)		141 (110V) 70 (220V)		70	70	18 (115V) 9 (230V)		11.1 (115V)		30.7 (115V) 17.6 (230V)		18 (115V) 7.9 (230V)		35 (115V) 16.7 (230V)	
	Type	Continuous Duty, Air Filled, 3600 RPM, 60Hz															
	Bearings	Double shielded, permanently lubricated, high-temp C3 with B-10 life of 60,000 hours															
	Insulation Class	E		B	F	B	E	E				E					
	Motor Protection (Built-In)	Miniature Protector		Circle Thermal Protector			Miniature Protector		Circle Thermal Protector		Miniature Protector		Circle Thermal Protector				
	Plug Configuration (NEMA)	5-15P (115V)		No Plug			5-15P (115V) No Plug (230V)		5-15P (115V)		5-15P (115V) No Plug (220V)		5-15P (115V) No Plug (230V)				
	Cable - # of Conductors x AWG	3C x 16AWG		3C x 12AWG		3C x 14AWG		3C x 16AWG				3C x 14AWG		3C x 16AWG		3C x 14AWG	
	Standard Cable Length (ft.)	32	20	32			32	20		32		32					
	Max. Cable Length (ft.)	110 (115V)		75 (110V) 300 (220V)		180	150	100 (115V) 380 (230V)		110 (115V)		100 (115V) 380 (230V)		45 (115V) 180 (230V)		48 (115V) 180 (230V)	
Recommended Generator Capacity (watts)	1230		8520		9060		2070		1280		3880		2080		4030		
Optional Float Switch	SLS-LSR32	SLS-LSC20	TS-304 (115V) TS-303 (220V)		TS-303		TS-301	TS-301	N/A	TS-302	N/A	TS-301	N/A	TS-302	N/A		
<b>DIMENSION</b>	Diameter (in.)	8 1/4	7 11/16	9 7/16	9 7/16	9 1/4	7 1/16	9 1/2	11 5/8	9 1/2	11 5/8	9 5/16	13	9 5/16	13		
	Height (in.)	11 3/8	12 7/16	24 1/2	24 3/16	26 1/2	14 7/16	13 3/4	15 3/4	16	18	14 3/16	23 7/8	14 15/16	24 5/8		
	Continuous Running Water Level (C.W.L.) (in.)	0.2	0.04	3 1/4	3 1/4	4 3/4	2 3/8	11 3/4	15 3/4 (Pump Starting Water Level)	13 3/4	18 (Pump Starting Water Level)	12 3/4	23 7/8 (Pump Starting Water Level)	13 5/8	24 5/8 (Pump Starting Water Level)		
	Shipping Weight (lbs.)	27	29	80	81	90	27	35	35	46	46	20	21	25	26		

## SPECIFICATIONS - ENGINE PUMPS: TE • EPT

		TE2-25H	TE3-50HA	TE3-80HA	TE2-100HA	EPT3-50HA	EPT3-80HA	EPT3-100HA	
		1" Dewatering Pump	2" Dewatering Pump	3" Dewatering Pump	4" Dewatering Pump	2" Trash Pump	3" Trash Pump	4" Trash Pump	
<b>FLUID</b>	Max. Capacity (GPM)	34	137	264	476	185	357	569	
	Max. Capacity (GPH)	2040	8200	15840	28560	11100	21420	34140	
	Max. Head (ft)	115	105	105	92			95	
	Max. Solid Diameter (in.)	0.197	0.217			0.787	1.22		
<b>PUMP</b>	Impeller Type	Semi-Open							
	Impeller Material	Cast Iron				High Chrome Casting			
	Volute Casing Material	Cast Iron							
	Wear Plate Material	Integral Part of Volute				Stainless Steel			
	Pump Casing Material	Die Cast Aluminum				Cast Aluminum			
	Shaft Seal – Type / Material	Silicon Carbide Mechanical Seal							
	Seal Lubricant – Type	Water							
	Discharge Connection	1" NPSH Coupling	2" NPT Coupling	3" NPT Coupling	4" NPT Coupling	2" NPT Coupling	3" NPT Coupling	4" NPT Coupling	
	Suction Connection	1" NPSH Coupling	2" NPT Coupling	3" NPT Coupling	4" NPT Coupling	2" NPT Coupling	3" NPT Coupling	4" NPT Coupling	
<b>ENGINE</b>	Brand	Honda							
	Model	GX-25	GX-120	GX-160	GX-240	GX-160	GX-240	GX-340	
	Type	Air-Cooled, 4-Cylinder w/ Oil Sensor							
	Output (HP)	1.1	4	5.5	8	5.5	8	11	
	RPM	2220	3600						
	Fuel	Unleaded Gasoline							
	Fuel Tank Capacity (US Gallon)	0.15	0.66	0.95	1.59	0.95	1.6	1.7	
	Continuous Run Time Per Tank (hr.)	1.21	3	3.3	3.2	3.3	3.2	2.6	
	Starting Method	Recoil Starter							
<b>DIMENSION</b>	Length (inches)	9	18 1/2	20 1/2	25	23 1/4	27 1/2	30 1/8	
	Width (inches)	14	14 5/8	16 1/2	18	18 1/4	20 1/8	20 1/8	
	Height (inches)	13	17 1/8	18 1/8	23 1/2	17 3/8	25 5/8	26	
	Shipping Weight (lbs.)	16	54	64	109	92	140	157	

## SPECIFICATIONS - ENGINE PUMPS: THP • TD(E) • EPT5-150

	THP-4070HA High Pressure Pump	TD6-200 2" Diaphragm Pump	TD6-300 3" Diaphragm Pump	TDE6-200 2" Electric Diaphragm Pump	TDE6-300 3" Electric Diaphragm Pump	EPT5-150HA 6" Trash Pump	EPT5-150KD 6" Trash Pump	
<b>FLUID</b>	Max. Capacity (GPM)	100	50	88	33	59	1000	
	Max. Capacity (GPH)	6000	3000	5280	1980	3540	60000	
	Max. Head (ft)	230	25				98	98
	Max. Solid Diameter (in.)	0.197	1 1/2	1 5/8	1 1/2	1 5/8	3	
<b>PUMP</b>	Impeller Type	Closed	Diaphragm				Semi-Open	
	Impeller (Diaphragm) Material	Aluminum	TPE				Stainless Steel	
	Volute Casing Material	Cast Iron	N/A				Cast Aluminum	
	Wear Plate Material	Integral Part of Volute	N/A				Cast Iron	
	Pump Casing Material	Cast Aluminum	Sand Cast Aluminum				Aluminum	
	Shaft Seal - Type / Material	Silicon Carbide Mechanical Seal	N/A				Silicon Carbide / Buna	
	Seal Lubricant - Type	Water	N/A				Water	
	Discharge Connection	1x2", 1.5"x1 NPSH Coupling	2" NPT Coupling	3" NPT Coupling	2" NPT Coupling	3" NPT Coupling	6" NPT Coupling	6" NPT Coupling
	Suction Connection	1.5" NPSH Coupling	2" NPT Coupling	3" NPT Coupling	2" NPT Coupling	3" NPT Coupling	6" NPT Coupling	6" NPT Coupling
<b>ENGINE</b>	Brand	Honda			N/A		Honda	Call for Information
	Model	GX-160	GX-120		N/A		GX-670	
	Type	Air-Cooled, 4-Cylinder with Oil Sensor			N/A		Air-Cooled V-Twin w/ Oil Sensor	Liquid Cooled, 4-Cycle, 3 Cylinder w/ Tach, Hour Meter / Oil Sensor
	Output (HP)	5.5	4			24		23.4
	RPM	3600			1725		3600	
	Fuel	Unleaded Gasoline			Electric Motor (115V)		Unleaded Gasoline	Diesel
	Fuel Tank Capacity (US Gallon)	0.95	0.5		Amperage 15.9 (115V) • 8 (230V)		20	
	Continuous Run Time Per Tank (hr.)	3.3	2	3	N/A		12	
Starting Method	Recoil Starter			N/A		12V Electric Start, (Battery not included)		
<b>DIMENSION</b>	Length (inches)	21	43	43	44	44	99	99
	Width (inches)	16	20	26	20	26	48	48
	Height (inches)	18	23	23	23	23	60	60
	Shipping Weight (lbs.)	62	165	175	175	185	1125	1250

## TPG SERIES PORTABLE GENERATORS

TSURUMI TPG4 Series Generators are designed to withstand the severe conditions of construction jobsites or industrial applications, especially where extra durability and dependable, stable power are required. Ideal to supply the power to Tsurumi's single-phase submersible pumps and all your electrical power tools such as drills, saws, lighting and heaters.

### TPG4 Series Generators Features *powered by Honda*

- High capacity fuel tank with fuel gauge for extended run time.
- Large, silent muffler with USDA qualified spark arrestor to greatly reduce noise.

Optional Accessories - See page 25 & 27

- Wheel Kit
- Lifting Bail



Powered by **Honda OHV engine** for efficient fuel consumption with oil alert system to shut off motor if oil falls below safe operating level.



Large air filter for **superior emission control**.

Automatic idle control reduces fuel consumption, noise, and engine wear.

Auto idle control switch on control panel.  
(Not available on TPG4-3000HCSA)

Rubber vibration pads isolate generator / engine set for **maximum protection and noise reduction**.

## SPECIFICATIONS - TPG4 Series Portable Generators



	TPG4-3000HCSA	TPG4-3400HCSA	TPG4-4500HCSA
Max. / Rated Output (watts)	2600 / 2200	3400/2900	4500 / 3600
Max. Current (120V / 240V)	21.7	28.3	37.5/30
Rated Current (120V / 240V)	18.3	24.2	18.7/15
Voltage (V) (60Hz)	120	120	120 / 240
AC Outlet Replacement	1-NEMA 5-20R Duplex (20A, 120V, W/GFCI)	2-NEMA 5-20R Duplex (20A, 120V, W/GFCI)	2-NEMA 5-20R Duplex (20A, 120V) 1-NEMA L5-30R (30A, 120V, Twist Lock) 1-NEMA L14-30R (30A, 120/240V, Twist Lock)
Engine Model	GX-160	GX-200	GX-240
Maximum HP	5.5 (3600RPM)	6.0 (3600RPM)	8.0 (3600RPM)
Displacement	163 (10inch <sup>3</sup> )	196 (12inch <sup>3</sup> )	242 (15inch <sup>3</sup> )
Fuel Tank Capacity (gallon)	4.2	4.2	6.6
Running Time (Rated load)	12.1	9	12.5
Starting System	Recoil	Recoil	Recoil
Noise Level (Rated Load)	75dB	76dB	75dB
Shipping Size (LxWxH) (inches)	24.4 x 19.3 x 20.9	24.4 x 19.3 x 20.9	28.0 x 23.6 x 22.0
Shipping Weight (lbs.)	112	124	169

	TPG4-6000HCSA	TPG4-7000HCSA TPG4-7000HECSA	TPG4-7500HCSA TPG4-7500HECSA
Max. / Rated Output (watts)	5500 / 4800	6800 / 6000	7500/6500
Max. Current (120V / 240V)	45.8/40	56.7/50	62.5/31.3
Rated Current (120V / 240V)	22.9/20	28.3/25	54.2/27.1
Voltage (V) (60Hz)	120 / 240	120 / 240	120/240
AC Outlet Replacement		2-NEMA 5-20R Duplex (20A, 120V) 1-NEMA L5-30R (30A, 120V, Twist Lock) 1-NEMA L14-30R (30A, 120/240V, Twist Lock)	
Engine Model	GX-340	GX-390	GX-390
Maximum HP	11.0 (3600RPM)	13.0 (3600RPM)	13.0 (3600RPM)
Displacement	337 (21inch <sup>3</sup> )	389 (24inch <sup>3</sup> )	389 (24inches <sup>3</sup> )
Fuel Tank Capacity (gallon)	6.6	6.6	6.6
Running Time (Rated load)	8.5	7.6	6.7
Starting System	Recoil	Recoil (HCSA) Recoil & Electric (HECSA)	Recoil (HCSA) Recoil & Electric (HECSA)
Noise Level (Rated Load)	72dB	79dB	80dB
Shipping Size (LxWxH) (inches)	28.0 x 23.6 x 22.0	28.0x 23.6 x 22.0	28.0 x 23.6 x 22.0
Shipping Weight (lbs.)	187	196(HCSA), 211(HECSA)	199(HCSA), 214(HECSA)

See Page 31 for Generator Accessories

**PUMP ACCESSORIES** for Electric Submersible Pumps, Engine Pumps & Portable Generators

**Automatic Float Switch** Model: TS-301/302/303/304, SLS-LSR32, SLS-LSC20

See Page 30-31 for more details



**TS-Series (TS-301/302/303/304)**

Piggy-back float switches allow fast & easy installation of Tsurumi submersible pumps for automated operation.

TS301/TS302: NEMA 5-15P plug; 30'  
TS303: NEMA 6-15P plug; 30'



**SLS-LSC20 / SLS-LSR32**

The surface level switch is used to automate a utility/floor sucking pump. Set the Surface Level Switch on the floor and plug the power cord from the pump into the piggyback plug on the switch. Plug the piggy-back plug into a standard 120 VAC wall outlet (the unit will also work on GFI outlets).



**Hoses**

See Page 26-27 for more details

**Hose Kit**



Hose Kit with NPT



Hose Kit with Quick Connect

**Discharge Hose**



NPT



Quick Connect

**Other Hoses**



Suction Hose

**Suction Hose**



NPT



Quick Connect

**Hose Accessories**



Quick Connect 'A'



Quick Connect 'F'



**PUMP ACCESSORIES** for Electric Submersible Pumps, Engine Pumps & Portable Generators

**Sand Kit**

**Model: K15-SK / K22-SK**

The Sand Kit can be added to the NK Series to suspend sand and prevent sand lock.



**Residue Kit**

**Model: HS-RK**

Available for the HS2.4S, the Residue Kit allows pumping of residual water down to 0.4 inches.



**Wheel Kit / Lifting Bail**



Wheel Kit  
for TPG4 Series Generator & Gas Engine Pumps



Lifting Bail

Heavy-duty and easy to install our wheel kits, and lifting bails fit Tsurumi engine pumps & generators.

**Wheel Kit**  
for TPG4 generators & TE/EPT/THP engine pumps







**Lifting Bail**  
for all TPG4 generators & TE/EPT/THP engine pumps\*  
\*excluding TPG4-3000HCSA

## PUMP ACCESSORIES GUIDE for Electric Submersible Pumps

### Electric Submersible Pumps

	Float Switch	Sand Kit	Residue Kit	2" Straight Discharge	3" Straight Discharge
<b>MODEL</b>					
LB-480	TS-301				
LB-480A					
LB-800	TS-302				
LB-800A					
LB-1500	TS-303 (220V Only)			032-351-11	
HS2.4S	TS-301		HS-RK	032-214-11	
HSZ2.4S			HS-RK	032-214-11	
HSE2.4S			HS-RK	032-214-11	
HS2.75S	TS-302				032-160-11
HSZ2.75S					032-160-11
HS3.75S	TS-302			032-158-16	032-160-11
HSZ3.75S				032-158-16	032-160-11
HS3.75SL	TS-302			032-158-16	032-160-11
HSZ3.75SL				032-158-16	032-160-11
HSD2.55S	TS-301			032-214-11	
NK2-15	TS-304 (115V) / TS-303 (220V)	K15-SK			
NK4-22	TS-303	K22-SK			
NK3-22L	TS-303				
LSR2.4S	SLS-LSR32				
LSC1.4S	SLS-LSC20			032-426-18	



### Electric Submersible Pumps (continued)

	2" Discharge Hose NPT	2" Discharge Hose Quick Connect	2" Quick Disconnect 'A'	3" Discharge Hose NPT	3" Discharge Hose Quick Connect	3" Quick Disconnect 'A'
<b>MODEL</b>						
LB-480	X	X	X			
LB-480A	X	X	X			
LB-800	X	X	X			
LB-800A	X	X	X			
LB-1500*	X	X	X	X	X	X
HS2.4S	X	X	X			
HSZ2.4S	X	X	X			
HSE2.4S	X	X	X			
HS2.75S	X	X	X			
HSZ2.75S	X	X	X			
HS3.75S				X	X	X
HSZ3.75S				X	X	X
HS3.75SL				X	X	X
HSZ3.75SL				X	X	X
HSD2.55S	X	X	X			
NK2-15				X	X	X
NK4-22				X	X	X
NK3-22L				X	X	X
LSR2.4S	X	X	X			
LSC1.4S						

\* Standard discharge size is 2". 3" is optional.

## PUMP ACCESSORIES GUIDE for Portable Generators

### Portable Generators

	Wheel Kit	Lifting Bail
	 Wheel kit ONLY	 Lifting Bail ONLY
MODEL		
TPG4-3000HCSA	X	
TPG4-3400HCSA	X	
TPG4-4500HCSA	X	X
TPG4-6000HCSA	X	X
TPG4-7000HCSA	X	X
TPG4-7000HECSA	X	X
TPG4-7500HCSA	X	X
TPG4-7500HECSA	X	X

**Anti-Wicking Cable Entrance:** Maximum protection against water incursion through the cable entry.

- Molded Cable Boot or Cable Protection Tube - extends cable bending radius, prevents abrading, and reduces fatigue.
- Cable Gland - provides 360 degree compression of cable boot, protection tube or cable bush for a water tight fit.
- Anti-Wicking Block - window cuts on conductor insulation expose strands to molded rubber or epoxy to prove water wicking through the strands and entering the motor providing protection even if the cable insulation is cut.

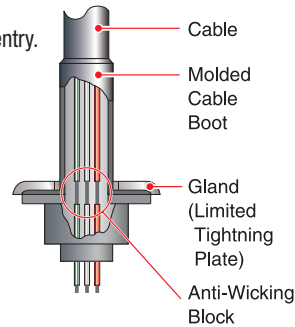

**Circle Thermal Protector (CTP):** For pumps with 1-10HP: 3-Pole protector connects to each winding of the motor and reacts to excessive heat and amperage. Automatic reset at safe temperature to restart the motor. No motor protection circuit required in starter or control panel.

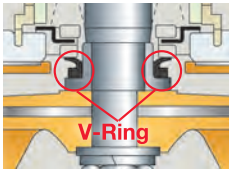

**V-Ring:** V-Ring is mounted at the top of the impeller and is brought in close contact to the bottom of the mechanical seal by the internal pressure of the pump casing. This V-Ring acts as a dust seal to prevent fine abrasive particles in the pumping fluid from reaching the mechanical seal.



**High-Performance Motor:** Dry type, squirrel-cage, induction motor, housed in a watertight casing, conforms to either insulation class B or E, or F. In both of these classes, all standard pumps can be used in ambient temperature up to 104°F (40°C).

**Dual Inside, Silicon Carbide Mechanical Seals:**

Isolation of mechanical seals in an oil chamber provides a clean, non-corrosive and abrasion free lubricating environment to prevent spring failure due to corrosion or abrasion and bottom seal failure due to loss of cooling during dry-run conditions.

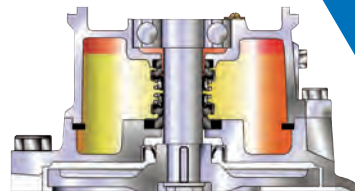

**Oil Lifter:** Tsurumi's Oil Lifter encloses the mechanical seal and uses the centrifugal force generated by the rotating shaft and seal to pump oil to the upper seal faces. Upper and lower seal faces are positively lubricated even when extremely low oil levels exist, as experienced after long periods of extended operation.

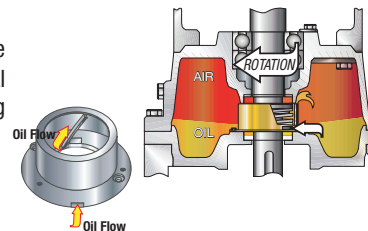

1156 avenue Lariviere  
Rouyn-Noranda, Québec, CANADA, J9X 4K8

Tel: 1-819-797-3300

[info@technosub.net](mailto:info@technosub.net)

For Sales, Service, and Specifications, call:  
**1 - 8 1 9 - 7 9 7 - 3 3 0 0**

Your Dealer