



**TSURUMI PUMP**<sup>®</sup>

BUILT FOR WORK<sup>®</sup>

SEWAGE AND  
WASTEWATER PUMPS



# SIMPLE DESIGN, EXTREME QUALITY | Tsurumi C Series CUTTER PUMP™

## Cable Entry

Cables are designed with an anti-wicking block at motor entry where each conductor insulation is window cut and the exposed stranded wire is encapsulated in molded rubber or epoxy which eliminates moisture from wicking into the motor.



## Motor

The air filled, continuous duty motors are designed to accommodate a maximum liquid temperature of 104°F. Higher temperature options may be available upon request.

## Mechanical Seal

Dual mechanical seal with silicon carbide faces sits within the oil chamber. The oil prevents corrosion, abrasion or fouling of the seal's spring and seal faces due to contamination, and also provides cooling and lubrication of the seal faces, even in run-dry conditions. These are common points of failure in designs where the seal is lubricated by the pumpage as opposed to oil.



## Oil Lifter

The Oil Lifter, utilizing centrifugal force, supplies lubricating oil to the upper seal faces even if oil falls below the rated volume, or pump is oriented horizontally.

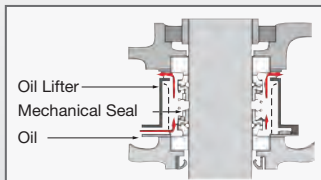

## Impeller & Cutter Plate

A tungsten carbide cutter is brazed onto the impeller vane, and rotates along the serrated entry of the cutter plate. Incoming fibrous matters are cut up which prevents clogging.

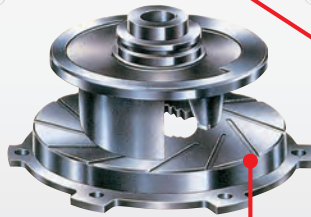

## Motor Protector

A Circle Thermal Protector (CTP) integrated in the motor housing directly cuts the motor circuit if excessive heat builds up or an electrical/mechanical failure leads to overcurrent.

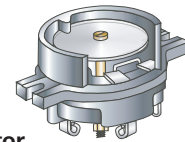

In pumps 15 HP and larger, a Miniature Thermal Protector (MTP) is embedded in each winding of the motors.

Should the winding temperature rise to the actuating temperature, the bimetal strip opens to cut off power supply.



## Moisture Sensor

An internal moisture sensor is standard for all pumps 30 HP and larger. An external moisture sensor is available as an option to detect intrusion of water in the oil chamber. Internal and External sensors, when wired to a control panel, alert the operator of a potential leak.

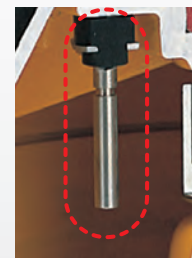

## GUIDE RAIL FITTING SYSTEM

The guide rail fitting system connects the pump to and from the piping easily just by lowering and hoisting the pump, allowing easy maintenance and inspection without the need to enter the sump. Pump models used in combination with the guide rail fitting system can be identified by the prefix "TOS / TO" and "TOK". Refer to standard specifications for availability and model numbers.

The **TOS / TO** is the standard guide rail fitting system made of cast-iron and is compatible with cast-iron pumps. Pumps having a discharge bore from 2 inches to 6 inches are available for the TOS, and from 8 inches to 32 inches are available for the TO.



The **TOK** guide rail connecting system is made of a high-quality corrosion resistant resin. This system is specifically designed for use with the corrosion resistant, light weight VANCS™ pumps (Page 16).



## MODEL NUMBER DESIGNATION

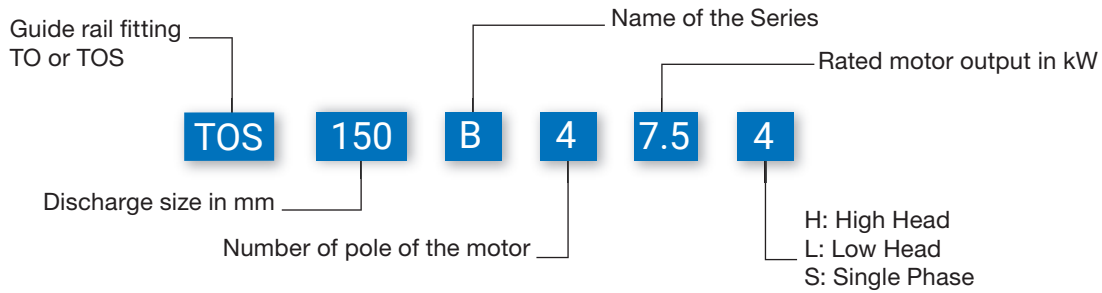

## INSTALLATION

### Free Standing

**Simple installation in the sump saves both money and space.**

Pump's with legs or a stand can sit directly on the sump floor. A discharge bend and flexible hosing allows for simple install/removal. Install the pump on a pump base if waste could clog or block its suction inlet.

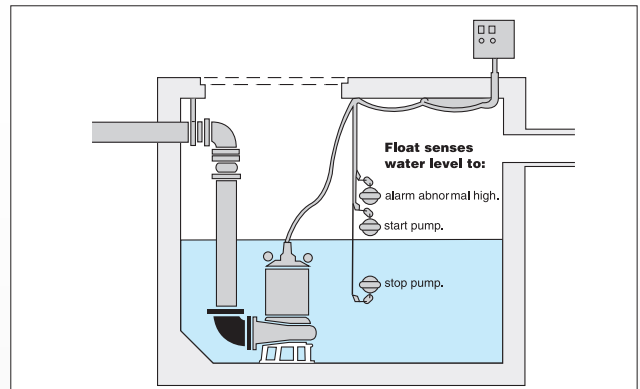

### Guide-Rail Fitting

**A guide rail suspends the pump with a chain for quick, easy installation or removal.**

Mount the pump on the rails using a guide hook above the discharge flange. As the pump is lowered, a hook on the discharge flange locks into and positions against the discharge elbow's flange. No tools or hardware are required as the weight of the pump seals the mated flanges. To remove the pump, simply raise with the chain and the pump will lift along the guide rails.

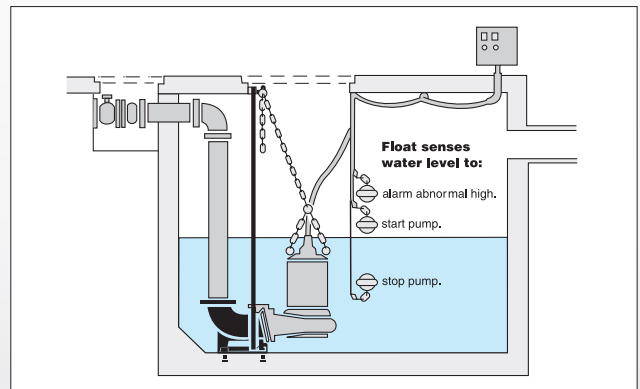

## DIMENSIONAL DRAWING DESCRIPTION

Dimension: Free Standing A / B / C

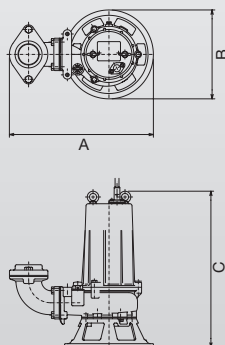

Dimension: Guide Rail Fitting (TO / TOS) D / E / F

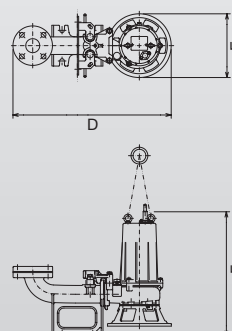

## B SERIES | Sewage & Wastewater Non-Clog Submersible Pump

Our B Series non-clog pumps are used primarily in municipal water supply stations and sewage treatment plants for pumping water, sewage, and digested sludge. In industry, these pumps are efficient for controlling cooling water, process and wastewater, and abrasive materials.

Solids handling, non-clog submersible pump designed for raw sewage and wastewater in municipal, industrial and commercial applications. Offered in 2" to 8" with multiple impeller designs for maximum flexibility.



100B42.2



With TO /TOS Guide Rail System

### Discharge Size: 2" - 3"

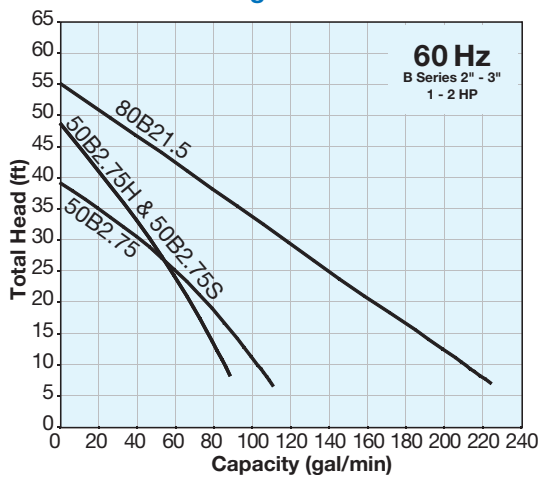

### Discharge Size: 4"

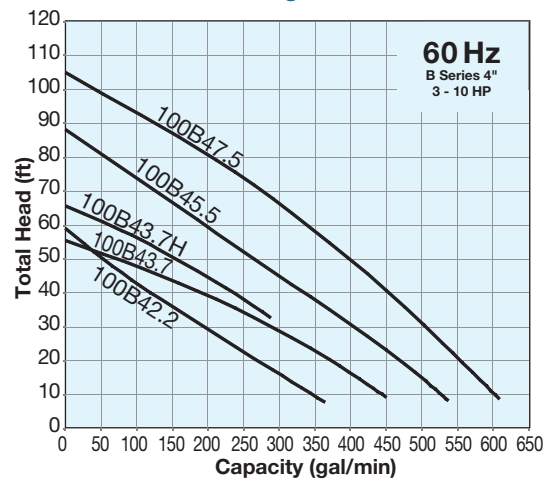

### Discharge Size: 6"

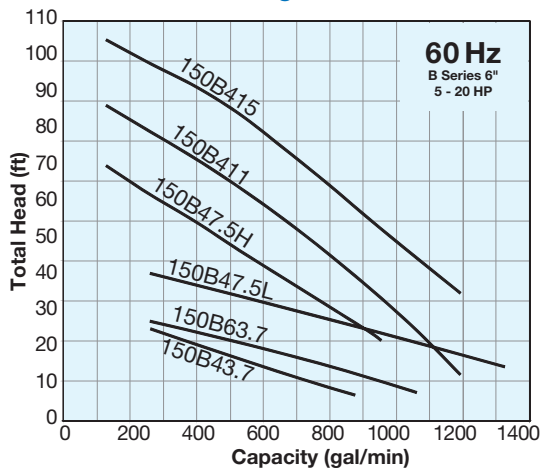

### Discharge Size: 8"

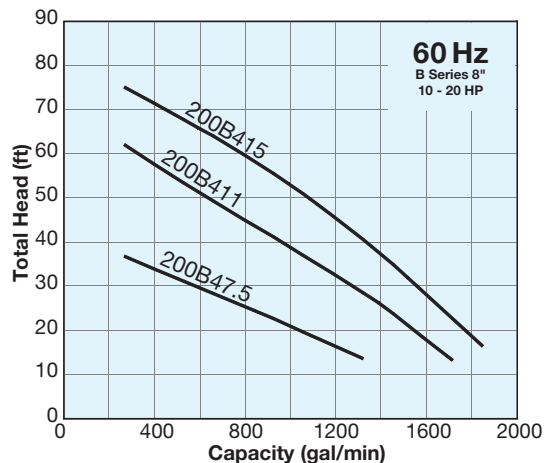

### Impeller types for B series

Open Channel

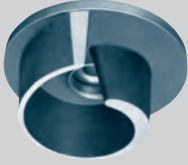

Solids Handling



Enclosed



Dimension: Free Standing A / B / C

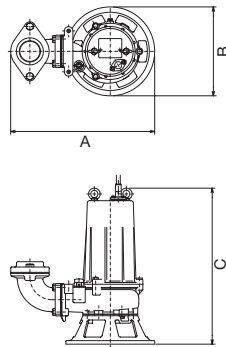

Dimension: Guide Rail Fitting (TO / TOS) D / E / F

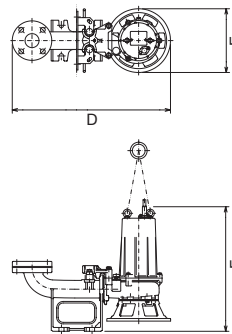

Single Phase Model	Motor Output (HP)	Rated Current (A)		*S.S. (RPM)	Discharge Size (in.)	Dimensions (in. / lbs.)						Max. Solids Dia. (in.)
		115V	230V			Free Standing Models			TOS Guide Rail Models			
		A	B			C	D	E	F			
50B2.75S	1	11.7	5.9	3600	2	15 15/16	9 13/16	20 9/16	24 7/16	9 13/16	22 5/16	0.79

Three Phase Model	Motor Output (HP)	Rated Current (A)				*S.S. (RPM)	Discharge Size (in.)	Dimensions (in. / lbs.)						Max. Solids Dia. (in.)
		208V	230V	460V	575V			Free Standing Models			TOS & TO Guide Rail Models			
		A	B	C	D			E	F					
50B2.75H	1	3.5	3.5	1.8	1.4	3600	2	15 15/16	9 13/16	16 5/16	24 7/16	9 13/16	18 1/16	0.79
50B2.75	1	3.5	3.5	1.8	1.4	3600	2	15 15/16	9 13/16	17 5/16	24 7/16	9 13/16	18 7/8	0.94
80B21.5	2	6.2	5.9	3.1	2.3	3600	3	17 9/16	9 13/16	21 1/8	26 5/8	9 13/16	23 1/16	1.38
100B42.2	3	9.4	8.5	4.3	3.5	1800	4 or 3	24 1/4	12 3/4	24 1/4	30 1/16	12 3/4	24 13/16	1.77
100B43.7H	5	15.0	13.8	6.9	5.4	1800	4 or 3	24 1/2	13 9/16	26 1/4	30 5/16	13 9/16	26 13/16	1.38
100B43.7	5	15.0	13.8	6.9	5.4	1800	4 or 3	24 7/16	13 1/8	27 3/16	30 1/4	13 1/8	27 9/16	1.77
150B43.7	5	14.7	13.8	6.9	5.4	1800	6	34 15/16	19 1/8	34 7/16	41 15/16	18 1/16	32 5/16	2.00
150B63.7	5	16.0	15.6	7.8	6.0	1200	6	33	16 11/16	35 9/16	40 5/16	15 9/16	36 7/16	2.17
100B45.5	7.5	22.6	20.5	10.3	8.1	1800	4	27 13/16	16 1/8	35 3/4	36	15 1/8	35 11/16	1.57
100B47.5	10	28.8	26.6	13.4	10.8	1800	4	27 13/16	16 1/8	36 9/16	36	15 1/8	36 1/2	1.57
150B47.5H	10	28.8	26.6	13.4	10.8	1800	6	32 13/16	16 7/16	37 1/2	40 1/2	15 7/8	38 7/16	2.76
150B47.5L	10	28.8	26.6	13.4	10.8	1800	6	34 5/16	19 1/8	42 11/16	41 15/16	18 1/16	40 9/16	1.97
200B47.5	10	28.8	26.6	13.4	10.8	1800	8	36 7/16	19 1/8	42 11/16	49 13/16	18 1/16	41 5/16	1.97
150B411	15	42.2	39.2	19.5	15.7	1800	6	35 1/4	19 5/16	43 1/4	42 7/8	18 1/4	41 7/16	2.95
200B411	15	42.2	39.2	19.5	15.7	1800	8	36 7/16	19 1/8	44 1/2	49 13/16	18 1/16	43 1/8	2.28
150B415	20	56.4	53.2	26.6	21.6	1800	6	35 1/4	19 5/16	46	42 7/8	18 1/4	44 3/16	2.95
200B415	20	56.4	53.2	26.6	21.6	1800	8	38 1/4	20 11/16	47 1/16	48 9/16	17 1/16	45 11/16	2.36

\* Synchronous Speed

## BK SERIES | Non-Clog Submersible Pump • Jacketed

The BK Series features an internal cooling jacket design to provide continued cooling even in the case of low sump level. This cooling jacket with the non-clog impeller design greatly reduces pump downtime. Offered in 30hp to 50hp three phase motor with discharge sizes ranging from 6" to 12".

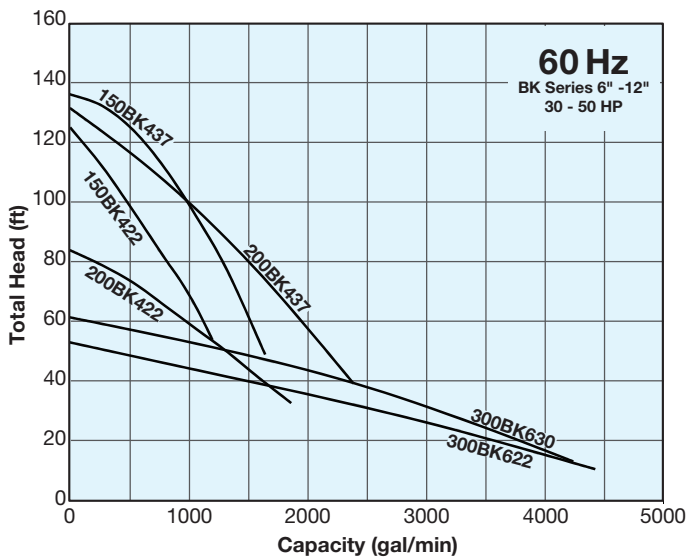

Dimension: Free Standing A / B / C

Dimension: Guide Rail Fitting (TO / TOS) D / E / F

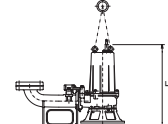
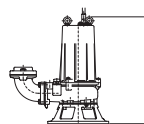
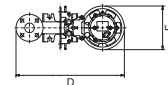
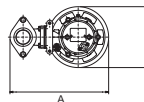

Three Phase Model	Motor Output (HP)	Rated Current (A)		*S.S. (RPM)	Discharge Size (in.)	Dimensions (in.)						Max. Solids Dia. (in.)
		460V	575V			Free Standing Models			TOS & TO Guide Rail Models			
						A	B	C	D	E	F	
150BK422	30	39	31.5	1800	6	38 7/8	21 1/4	52 1/8	46 1/4	20 1/2	51 5/16	2.95
200BK422	30	39	31.5	1800	8	42 13/16	24 7/16	50 3/4	53 3/8	21 5/8	51 15/16	2.95
300BK622	30	41	33	1200	12	53 3/4	29 15/16	63 9/16	66 5/16	27 3/8	63 11/16	3.27
300BK630	40	56	45	1200	12	53 3/4	29 15/16	67 3/16	66 5/16	27 3/8	67 5/16	2.76
150BK437	50	64	50	1800	6	42 11/16	28 1/2	63 11/16	51 7/16	24 7/16	57 1/16	1.57
200BK437	50	64	50	1800	8	46 7/8	28 1/2	64 9/16	56 3/16	24 3/8	60 1/8	1.57

\* Synchronous Speed

## BZ SERIES | Non-Clog Submersible Pump • Jacketed & Non-Jacketed

Highly reliable and durable, Tsurumi BZ Series pumps are designed and built for sound quality and continuous duty that can help you keep your systems - whether for wastewater drainage, pumping or flood control - running stably and greatly reduce your maintenance costs. As an option, the pumps can be adapted for seawater, high temperature liquids or other special application, paving the way for their use at shipyards and power plants for water intake and discharge.



100BZ47.5



250BZ455



200BZ622

### Shrouded Channel Impeller with Wide Passages to Prevent Clogging

#### – Over 3 Inches Passage –

BZ Series pumps come with wide passages of over 3 inches in diameter to minimize trouble due to clogged solids and fibrous matter. They adopt a shrouded single/two-channel impeller.



Shrouded Channel Impeller

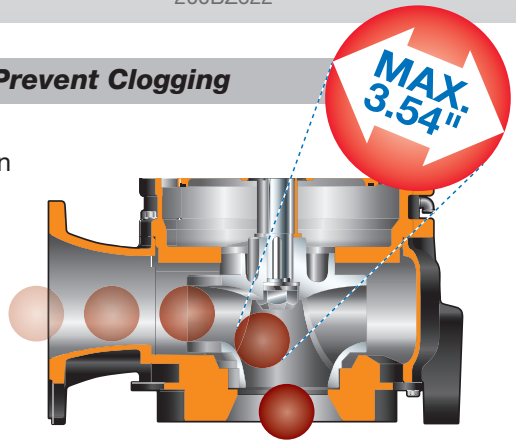

# BZ SERIES | Non-Clog Submersible Pump • Jacketed & Non-Jacketed

## Group Curves

### BZ Series: Jacketed

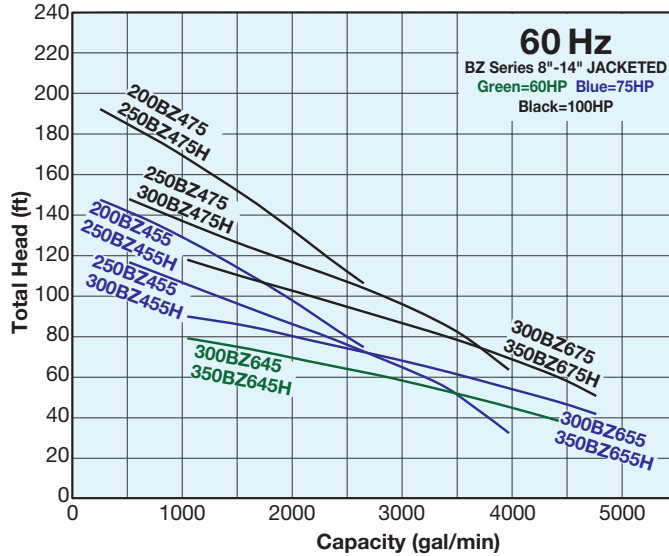

### BZ Series: Non-Jacketed

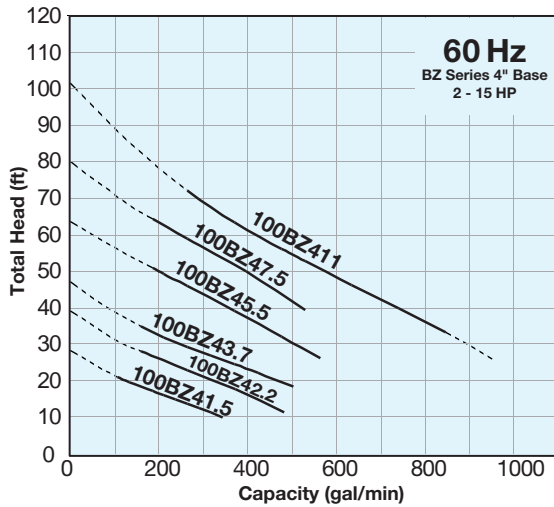

REMARKS: Not Recommended for Continuous Operation On Dashed Curve.

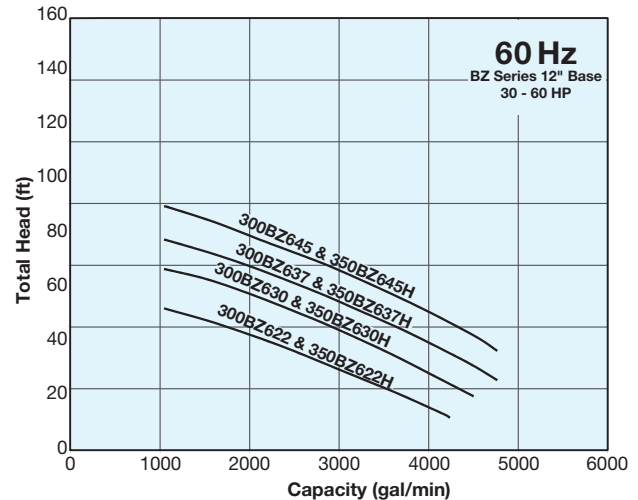
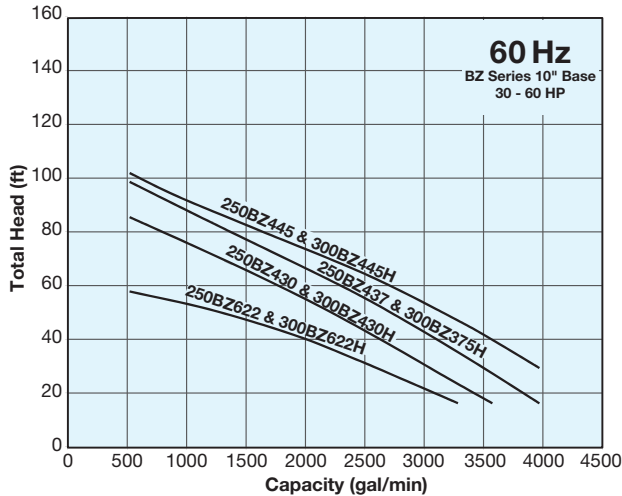
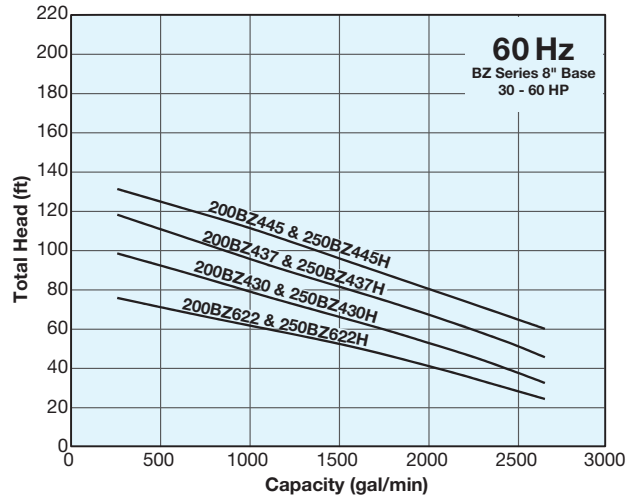



# BZ SERIES | Non-Clog Submersible Pump • Jacketed & Non-Jacketed

## Specifications

### BZ Series: Jacketed

Three Phase Model	Motor Output (HP)	Rated Current (A)				*S.S. (RPM)	Discharge Size (in.)	Dimensions (in.)						Max. Solids Dia. (in.)
		208V	230V	460V	575V			Free Standing Models			TOS Guide Rail Models			
								A	B	C	D	E	F	
200BZ455	75	N/A	N/A	CF	CF	1800	8	47 9/16	29 15/16	68 3/8	57 1/2	26	64 13/16	3.00
250BZ455H	75	N/A	N/A	CF	CF	1800	10	51 11/16	29 15/16	68 3/8	62 1/16	26	63 3/4	3.00
200BZ475	100	N/A	N/A	CF	CF	1800	8	47 9/16	29 15/16	68 3/8	56 9/16	26	64 13/16	3.00
250BZ475H	100	N/A	N/A	CF	CF	1800	10	51 11/16	29 15/16	68 3/8	62 1/16	26	63 3/4	3.00
250BZ455	75	N/A	N/A	CF	CF	1800	10	48 5/8	28 1/2	70 15/16	58 1/2	25 1/16	65 9/16	3.15
300BZ455H	75	N/A	N/A	CF	CF	1800	12	50 11/16	28 1/2	70 15/16	62 3/16	25 1/16	66 1/2	3.15
250BZ475	100	N/A	N/A	CF	CF	1800	10	48 5/8	28 1/2	70 15/16	58 1/2	25 1/16	65 9/16	3.15
300BZ475H	100	N/A	N/A	CF	CF	1800	12	50 11/16	28 1/2	70 15/16	62 3/16	25 1/16	66 1/2	3.15
300BZ645	60	N/A	N/A	CF	CF	1200	12	54 9/16	31 1/2	72 5/8	65 7/8	26 3/4	67 5/8	3.54
350BZ645H	60	N/A	N/A	CF	CF	1200	14	59 3/8	31 1/2	72 5/8	68 7/8	26 3/4	69 7/16	3.54
300BZ655	75	N/A	N/A	CF	CF	1200	12	54 9/16	31 1/2	72 5/8	65 7/8	26 3/4	67 5/8	3.54
350BZ655H	75	N/A	N/A	CF	CF	1200	14	59 3/8	31 1/2	72 5/8	68 7/8	26 3/4	69 7/16	3.54
300BZ475	100	N/A	N/A	CF	CF	1800	12	54 9/16	31 1/2	72	65 7/8	26 3/4	67	3.54
350BZ475H	100	N/A	N/A	CF	CF	1800	14	59 3/8	31 1/2	72	68 7/8	26 3/4	68 3/4	3.54

\*CF: Consult Factory

\* Synchronous Speed

### BZ Series: Non-Jacketed

Three Phase Model	Motor Output (HP)	Rated Current (A)				*S.S. (RPM)	Discharge Size (in.)	Dimensions (in.)						Max. Solids Dia. (in.)
		208V	230V	460V	575V			Free Standing Models			TOS Guide Rail Models			
								A	B	C	D	E	F	
100BZ41.5	2	8.0	8.0	4.0	3.0	1800	4	22 1/2	10 3/4	24 13/16	28 5/16	10 3/4	25 7/16	3.15
100BZ42.2	3	9.8	9.2	4.6	3.6	1800	4	22 1/2	10 3/4	24 13/16	28 5/16	10 3/4	25 7/16	3.15
100BZ43.7	5	15.0	14.2	7.3	5.4	1800	4	23 13/16	11 3/8	26 13/16	29 5/8	11 3/8	27 3/8	3.15
100BZ45.5	7.5	22.2	20.8	10.4	8.3	1800	4	29	16 9/16	36 7/16	37 3/16	16	36	3.15
100BZ47.5	10	29.8	28.0	14.0	11.5	1800	4	29	16 9/16	37 3/16	37 3/16	16	36 13/16	3.15
100BZ411	15	41.4	38.0	19.0	14.7	1800	4	29 7/16	16 15/16	40 1/4	37 5/8	16 7/8	40	3.15
200BZ622	30	N/A	N/A	CF	CF	1200	8	47 9/16	29 15/16	62 3/8	57 7/16	26	58 13/16	3.00
250BZ622H	30	N/A	N/A	CF	CF	1200	10	51 11/16	29 15/16	62 3/8	62 1/16	26	57 3/4	3.00
200BZ430	40	N/A	N/A	CF	CF	1800	8	47 9/16	29 15/16	59 3/16	57 7/16	26	55 1/2	3.00
250BZ430H	40	N/A	N/A	CF	CF	1800	10	51 11/16	29 15/16	59 3/16	62 1/8	26	54 1/2	3.00
200BZ437	50	N/A	N/A	CF	CF	1800	8	47 9/16	29 15/16	61 7/8	57 7/16	26	58 3/8	3.00
250BZ437H	50	N/A	N/A	CF	CF	1800	10	51 11/16	29 15/16	61 7/8	62 1/16	26	57 5/16	3.00
200BZ445	60	N/A	N/A	CF	CF	1800	8	47 9/16	29 15/16	62 3/8	57 7/16	26	58 13/16	3.00
250BZ445H	60	N/A	N/A	CF	CF	1800	10	51 11/16	29 15/16	62 3/8	62 1/16	26	57 3/4	3.00
250BZ622	30	N/A	N/A	CF	CF	1200	10	48 5/8	28 1/2	64 15/16	58 1/2	24 1/4	59 5/8	3.15
300BZ622H	30	N/A	N/A	CF	CF	1200	12	50 11/16	28 1/2	64 15/16	62 3/16	24 1/4	60 1/2	3.15
250BZ430	40	N/A	N/A	CF	CF	1800	10	48 5/8	28 1/2	61 13/16	58 1/2	24 1/4	56 7/16	3.11
300BZ430H	40	N/A	N/A	CF	CF	1800	12	50 11/16	28 1/2	61 13/16	62 3/16	24 1/4	57 3/8	3.11
250BZ437	50	N/A	N/A	CF	CF	1800	10	48 5/8	28 1/2	64 1/2	58 1/2	24 1/4	59 9/16	3.11
300BZ437H	50	N/A	N/A	CF	CF	1800	12	50 11/16	28 1/2	64 1/2	62 3/16	24 1/4	60 1/16	3.11
250BZ445	60	N/A	N/A	CF	CF	1800	10	48 5/8	28 1/2	64 15/16	58 1/2	24 1/4	59 5/8	3.11
300BZ445H	60	N/A	N/A	CF	CF	1800	12	50 11/16	28 1/2	64 15/16	62 3/16	24 1/4	60 1/2	3.11
300BZ622	30	N/A	N/A	CF	CF	1200	12	54 9/16	31 1/2	66	65 7/8	25 7/8	61	3.54
350BZ622H	30	N/A	N/A	CF	CF	1200	14	59 3/8	31 1/2	66	68 7/8	25 7/8	62 13/16	3.54
300BZ630	40	N/A	N/A	CF	CF	1200	12	54 9/16	31 1/2	66	65 7/8	25 7/8	61	3.54
350BZ630H	40	N/A	N/A	CF	CF	1200	14	59 3/8	31 1/2	66	68 7/8	25 7/8	62 13/16	3.54
300BZ637	50	N/A	N/A	CF	CF	1200	12	54 9/16	31 1/2	66	65 7/8	25 7/8	61	3.54
350BZ637H	50	N/A	N/A	CF	CF	1200	14	59 3/8	31 1/2	66	68 7/8	25 7/8	62 13/16	3.54

\* Synchronous Speed

Dimension: Free Standing A / B / C

Dimension: Guide Rail Fitting (TO / TOS) D / E / F

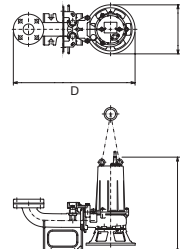
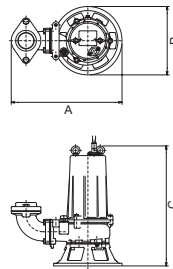

## C SERIES | Tsurumi C Series CUTTER PUMP™

Tsurumi C Series Cutter Pump™ is a solids handling non-clog submersible pump with a unique tungsten carbide tipped single or multi-vane impeller and high chrome serrated wear plate for shredding of solids. Designed for municipal, industrial and commercial applications; the C-Series is offered in 1hp to 30hp single and three phase motors.

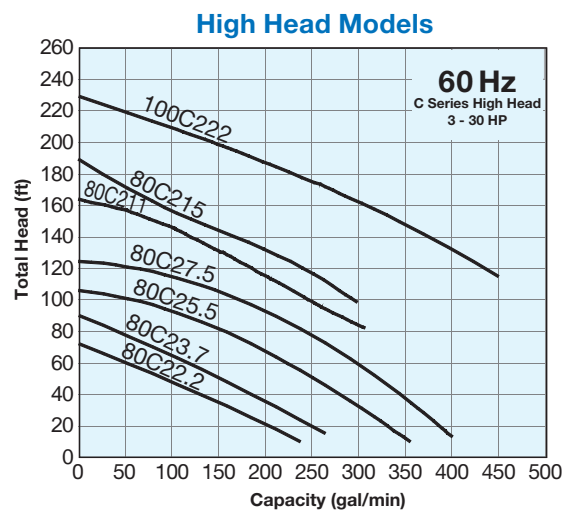
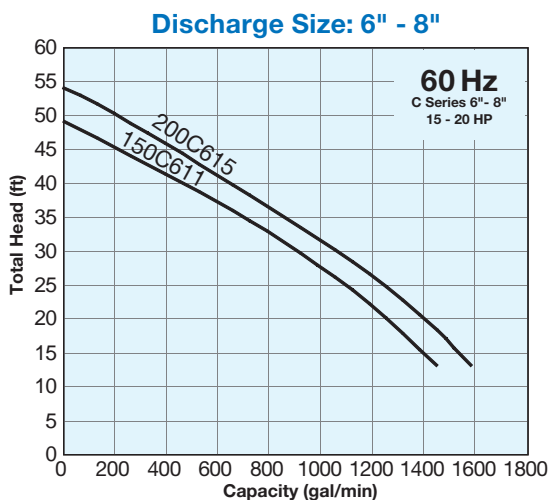
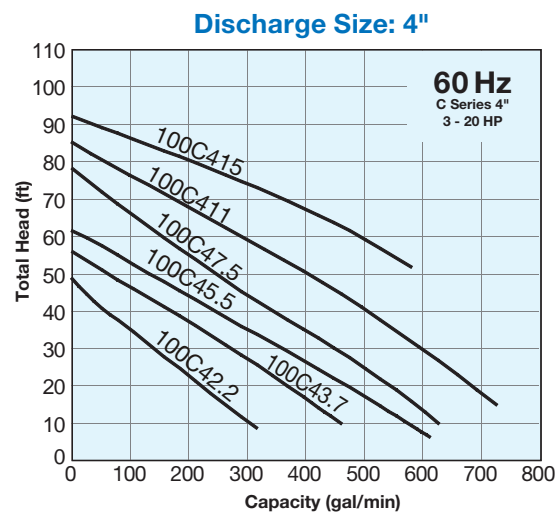
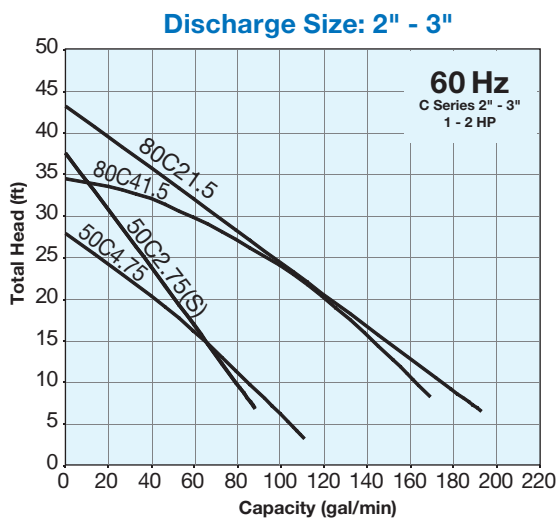
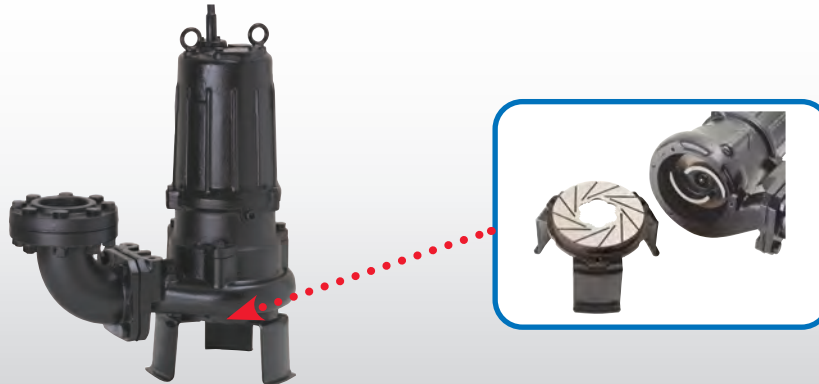

## Applications

- Municipal wet well lift stations
- Municipal dry pit stations
- Retail stores / restaurants
- Sewer bypass
- Nursing homes / housing developments
- Prisons
- Hospitals
- Pulp and paper mills
- Industrial processing
- Oil refining
- Food processing
- Farming
- Campgrounds
- Hotels

## Optional Discharge with 3" & 4" Discharge Size

Reduced overall width allows pump to be used in confined areas, including sewer bypass applications. Please contact factory for specific dimensions.  
(Also compatible with other models)



Dimension: Free Standing A / B / C

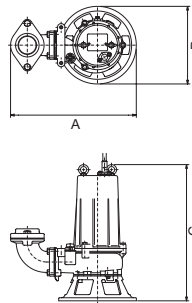

Dimension: Guide Rail Fitting (TO / TOS) D / E / F

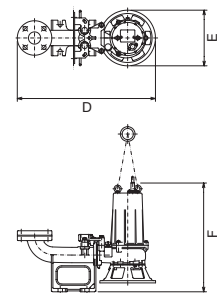

Single Phase Model	Motor Output (HP)	Rated Current (A)		*S.S. (RPM)	Discharge Size (in.)	Dimensions (in.)						Max. Solids Dia. (in.)
		115V	230V			Free Standing Models			TOS Guide Rail Models			
						A	B	C	D	E	F	
50C2.75S*	1	11.7	5.9	3600	2	15 15/16	9 13/16	20 9/16	24 7/16	9 13/16	22 5/16	0.83

Three Phase Model	Motor Output (HP)	Rated Current (A)				*S.S. (RPM)	Discharge Size (in.)	Dimensions (in.)						Max. Solids Dia. (in.)
		208V	230V	460V	575V			Free Standing Models			TOS Guide Rail Models			
								A	B	C	D	E	F	
50C2.75*	1	3.5	3.5	1.8	1.4	3600	2	15 15/16	9 13/16	16 5/16	24 7/16	9 13/16	18 1/16	0.83
50C4.75	1	3.5	3.6	1.8	1.5	3600	2	16 13/16	11 3/16	19 5/8	25 5/16	11 3/16	21 9/16	1.02
80C21.5*	2	6.2	5.9	3.1	2.3	3600	3	17 9/16	9 13/16	21 1/8	26 5/8	9 13/16	23 1/16	1.18
80C41.5	2	6.6	6.4	3.2	2.6	1800	3	19 5/8	12 7/16	22 5/8	28 11/16	12 7/16	23 7/8	1.26
100C42.2	3	9.4	8.5	4.3	3.5	1800	4 or 3	24 3/16	12 3/4	24 1/4	30 1/16	12 3/4	24 13/16	1.73
100C43.7	5	15.0	13.8	6.9	5.4	1800	4 or 3	24 3/8	13 1/8	27 3/16	30 1/4	13 1/8	27 9/16	2.17
100C45.5	7.5	22.2	20.8	10.4	8.1	1800	4	27 13/16	16 1/8	35 3/4	36	15 1/8	35 11/16	1.57
100C47.5	10	29.8	28.0	14.0	10.8	1800	4	27 13/16	16 1/8	36 9/16	36	15 1/8	36 1/2	1.57
100C411	15	41.4	38.0	19.0	14.7	1800	4	28 11/16	17 3/16	39 3/8	37 1/8	16 15/16	39 5/16	1.97
100C415	20	55.8	51.6	25.8	20.6	1800	4	28 5/8	17 3/16	42 1/2	36 13/16	16 11/16	42 7/16	1.57
150C611	15	43.0	39.0	19.5	15.5	1200	6	41 1/16	23 11/16	47 11/16	48 3/8	22	46 5/16	3.62
200C615	20	58.0	52.0	26.0	21.0	1200	8	43 1/4	23 11/16	49 5/8	56 1/4	22	49 1/16	3.62

\* Not for use in commercial applications (Residential sewage only)

Three Phase Model: High Head	Motor Output (HP)	Rated Current (A)				*S.S. (RPM)	Discharge Size (in.)	Dimensions (in.)						Max. Solids Dia. (in.)
		208V	230V	460V	575V			Free Standing Models			TOS Guide Rail Models			
								A	B	C	D	E	F	
80C22.2	3	10.0	9.8	4.9	3.8	3600	3	21 1/8	10 1/4	24 1/16	27 5/16	10 1/4	25 3/16	0.79
80C23.7	5	14.4	13.6	6.8	5.3	3600	3	21 1/8	10 1/4	24 1/16	27 5/16	10 1/4	25 3/16	0.87
80C25.5	7.5	22.3	21.4	10.7	8.3	3600	3	24 15/16	13 9/16	34 5/8	31 1/16	12 5/8	35 1/2	0.91
80C27.5	10	26.9	25.6	13.0	10.2	3600	3	24 15/16	13 9/16	34 5/8	31 1/16	12 5/8	35 1/2	0.91
80C211	15	40.8	39.2	19.6	15.4	3600	3	24 15/16	13 9/16	36 1/2	31 1/16	12 5/8	36 7/16	0.98
80C215	20	54.0	50.0	25.0	20.0	3600	3	28 3/4	16 15/16	42 3/4	36 13/16	16 15/16	42 3/4	1.02
100C222	30	---	---	35.0	28.0	3600	4	33 3/4	20 1/16	46 5/8	40 3/8	20 1/16	46 5/8	1.02

\* S.S. = Synchronous Speed

## U SERIES | Semi-Vortex Cast Iron Impeller

Tsurumi's U Series pumps provide exceptional capabilities for those small to mid-range applications in which solids and stringy materials can be problematic.

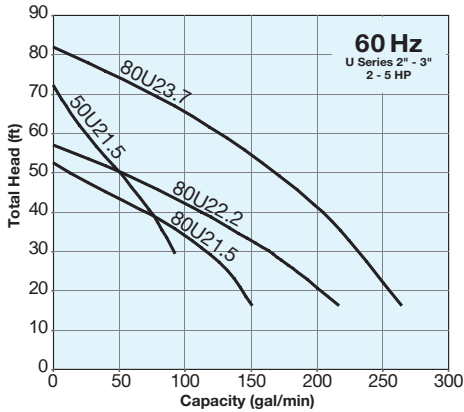

U Series pump with elbow

Dimension: Free Standing A / B / C    Dimension: Guide Rail Fitting (TO / TOS) D / E / F

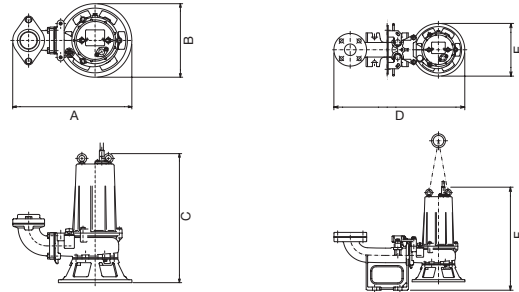

Three Phase Model	Motor Output (HP)	Rated Current (A)				*S.S. (RPM)	Discharge Size (in.)	Dimensions (in.)						Max. Solids Dia. (in.)
		208V	230V	460V	575V			Free Standing Models			TOS Guide Rail Models			
								A	B	C	D	E	F	
50U21.5	2	6.2	5.9	3.1	2.3	3600	2	11 11/16	7 15/16	18 3/8	25 7/8	7 15/16	18 13/16	1.38
80U21.5	2	6.2	5.9	3.1	2.3	3600	3	16 9/16	7 15/16	19 5/8	23 7/8	7 15/16	23 11/16	1.81
80U22.2	3	9.4	8.8	4.4	3.5	3600	3	20 1/2	9 7/16	22 1/8	24 15/16	9 7/16	25 1/2	2.20
80U23.7	5	14.4	13.6	6.8	5.3	3600	3	20 1/2	9 3/16	22 1/4	24 15/16	9 3/16	25 9/16	2.20

\* Synchronous Speed

## UT • UTZ SERIES | Single Phase Cast Iron Submersible Sewage Pump

The UT Series pumps are compact economical cast iron pumps. It features a large passage ideal for applications with solids laden liquids. Available with float switches for automatic operation (50UTZ2.4S and 50UTZ2.75S).

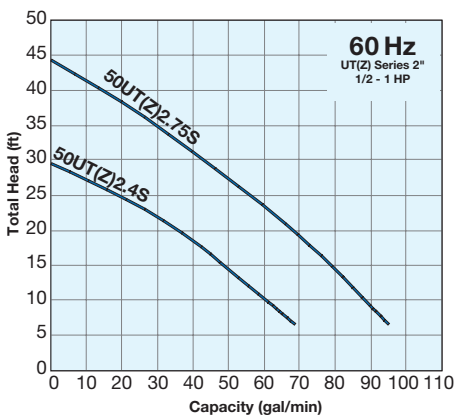

50UT2.4S



50UTZ2.4S

Dimension: 50UT2.4S/2.75S

Dimension: 50UTZ2.4S/2.75S

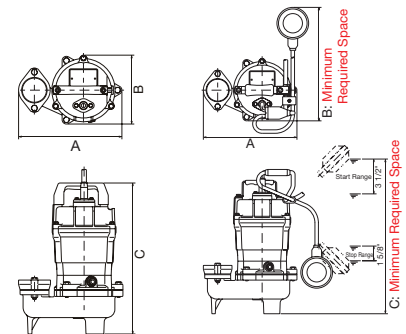

Single Phase Model	Motor Output (HP)	Rated Current (A)		*S.S. (RPM)	Discharge Size (in.)	Dimensions (in.)			Max. Solids Dia. (in.)
		115V	230V			Free Standing Models			
						A	B	C	
50UT2.4S	1/2	5.7	—	3600	2	9 1/2	6 3/8	13 3/4	1.40
50UTZ2.4S	1/2	5.7	—	3600	2	9 1/2	11 5/8 <sup>*1</sup>	15 3/4 <sup>*1</sup>	1.40
50UT2.75S	1	9.9	5.2	3600	2	9 1/2	6 3/8	16	1.40
50UTZ2.75S	1	9.9	5.2	3600	2	9 1/2	11 5/8 <sup>*1</sup>	18 <sup>*1</sup>	1.40

(Suffix Z: Automatic Operation)

\* Synchronous Speed

<sup>\*1</sup>: Minimum Required Space

# UZ SERIES | Full-Vortex Cast Iron Impeller

Features a vortex impeller and wide pump casing interior, effectively pumping and discharging water containing solids and fibrous foreign matters.



UZ Series pump with elbow



With TOS Guide Rail System

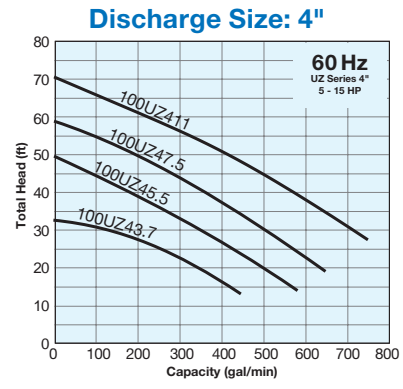
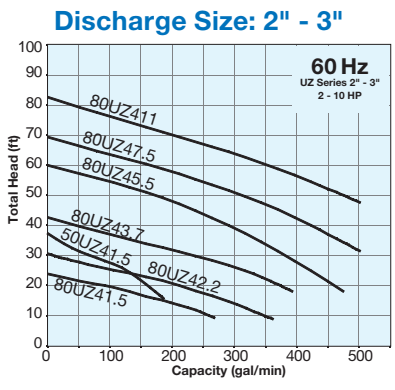

Dimension: Free Standing A / B / C

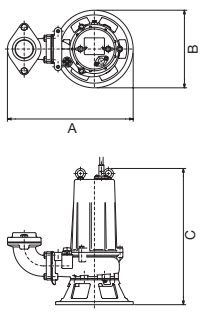

Dimension: Guide Rail Fitting (TO / TOS) D / E / F

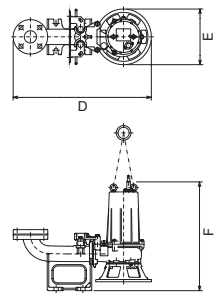

Three Phase Model	Motor Output (HP)	Rated Current (A)				*S.S. (RPM)	Discharge Size (in.)	Dimensions (in.)						Max. Solids Dia. (in.)
		208V	230V	460V	575V			Free Standing Models			TOS Guide Rail Models			
								A	B	C	D	E	F	
50UZ41.5	2	7.3	7.0	3.5	2.9	1800	2	15 15/16	9 3/4	22 5/16	24 7/16	9 3/4	24 5/8	1.97
80UZ41.5	2	7.3	7.0	3.5	2.9	1800	3	21 5/8	10 1/4	25 1/16	28 1/16	10 1/4	26 3/8	3.15
80UZ42.2	3	9.4	9.2	4.6	3.6	1800	3	21 5/8	10 1/4	25 1/16	28 1/16	10 1/4	26 3/8	3.15
80UZ43.7	5	14.8	14.2	6.9	5.4	1800	3	22 11/16	11 7/16	27 1/16	29 1/8	11 7/16	28 3/8	3.15
100UZ43.7	5	14.8	13.8	6.9	5.4	1800	4	25 1/2	12 3/8	29	33 11/16	12 3/8	30 9/16	3.94
80UZ45.5	7.5	22.6	20.5	10.3	8.1	1800	3	24 1/8	14 1/8	35 3/8	30 9/16	14 1/8	36 1/2	3.15
100UZ45.5	7.5	22.6	20.5	10.3	8.1	1800	4	26 7/16	14 1/8	36 15/16	34 11/16	14 1/8	38 3/8	3.94
80UZ47.5	10	28.8	26.6	13.4	10.8	1800	3	24 1/8	14 1/8	36 1/4	30 9/16	14 1/8	37 5/16	3.15
100UZ47.5	10	28.8	26.6	13.4	10.8	1800	4	26 7/16	14 1/8	37 13/16	34 11/16	14 1/8	39 3/16	3.94
80UZ411	15	41.4	38.0	19.0	14.7	1800	3	24 7/16	14 1/8	38 5/8	30 7/8	14 1/8	39 5/8	3.15
100UZ411	15	41.4	38.0	19.0	14.7	1800	4	26 3/4	14 1/8	40 3/16	35	14 1/8	41 1/2	3.94

\* Synchronous Speed

## MG SERIES | Semi-Vortex High Chrome Impeller

Tsurumi submersible grinder pumps utilize a grinding mechanism in the suction port to crush foreign matter into fine particles before discharging the waste. The pump utilizes a recessed vortex impeller that moves the fibrous matter without causing wear to the impeller.

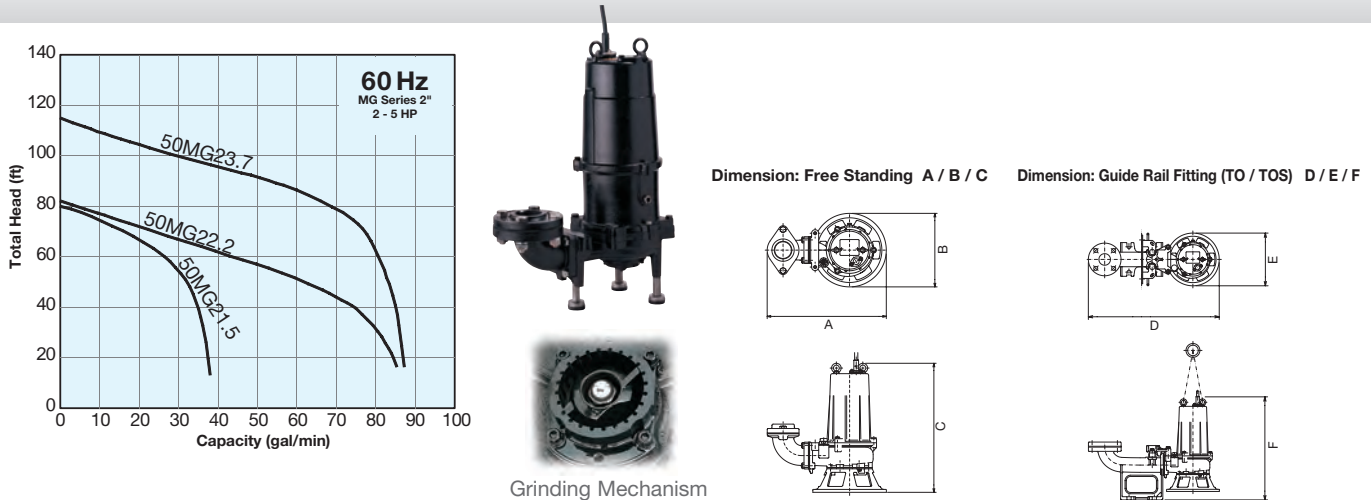

Three Phase Model	Motor Output (HP)	Rated Current (A)				*S.S. (RPM)	Discharge Size (in.)	Dimensions (in.)						Max. Solids Dia. (in.)
		208V	230V	460V	575V			Free Standing Models			TOS Guide Rail Models			
								A	B	C	D	E	F	
50MG21.5	2	6.7	6.6	3.3	2.6	3600	2	14 5/16	8 9/16	21 15/16	24 3/8	8 9/16	23 1/8	0.2
50MG22.2	3	10.0	9.8	4.9	3.8	3600	2	17 1/4	8 7/8	23 3/8	24 3/8	8 7/8	24 11/16	0.2
50MG23.7	5	14.4	13.6	6.8	5.3	3600	2	17 1/4	8 7/8	23 3/8	24 3/8	8 7/8	24 11/16	0.2

\* Synchronous Speed

## SQ SERIES | Compact & Lightweight Corrosion Resistant Pump

The SQ pump features a top discharge, flow-thru design with forced motor cooling that enables extended running at low water level. In addition, the SQ pump fits into an 8-inch pipe.

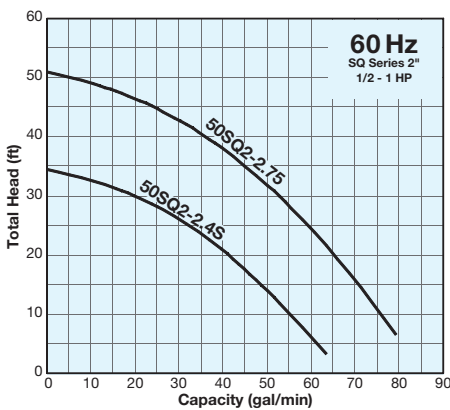

- It is made of 304 / 316 stainless steel, Nitrile Butadiene Rubber and special resin to stand up to rust and corrosion, and sport a new structural design that makes them even lighter and easier to carry
- Non-toxic white mineral oil used to lubricate mechanical seals
- Motor protector protects against overheating and run-dry
- Designed to fit into an 8-inch pipe



50SQ2-2.4S

Single Phase Model	Motor Output (HP)	Rated Current (A)				*S.S. (RPM)	Discharge Size (in.)	Dimensions (in.)			Max. Solids Dia. (in.)
		115V		230V				Free Standing Models			
		A	B	C	D	A	B	C			
50SQ2-2.4S	1/2	5.1	2.9			3600	2	7 1/16	7 1/16	14 7/16	0.236
Three Phase Model	Motor Output (HP)	Rated Current (A)				*S.S. (RPM)	Discharge Size (in.)	Dimensions (in.)			Max. Solids Dia. (in.)
		208V	220V	460V	575V			Free Standing Models			
		A	B	C	D	A	B	C			
50SQ2-2.75	1	3.4	3.5	2.0	1.5	3600	2	7 1/16	7 1/16	15 3/16	0.236

\* Synchronous Speed

Dimension: Free Standing

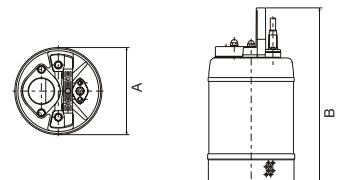

# SFQ SERIES | Stainless Steel Pump

Submersible drainage/dewatering pump designed for corrosive liquids and atmospheres. All cast 316 Stainless Steel construction with viton elastomers and semi-open Stainless Steel impeller. Offered in three phase, 1HP - 15HP models at 208V - 230V, 460V and 575V & 2", 3" and 4" discharge sizes.



80SFQ211

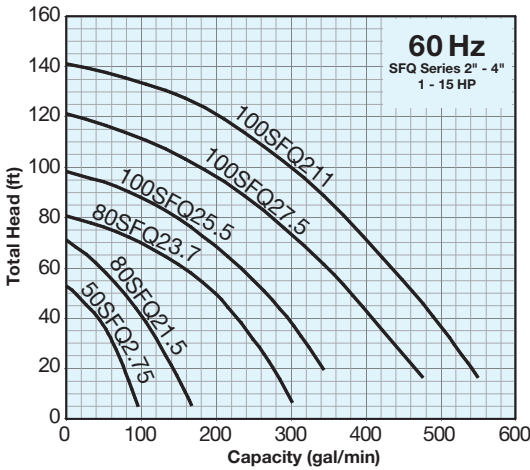

- All wetted material components are 316 Stainless Steel
- Dual inside mechanical seals with Silicon Carbide faces, running in an oil filled chamber and further protected by exclusionary lip seal, providing the most durable seal available
- Optional 316 Stainless Steel slide rail system is available for models from 7.5HP - 15HP
- Seal pressure relief system features an independent chamber separate from the oil casing in which the mechanical seal is housed
- Optional: High temperature winding (available on all series)

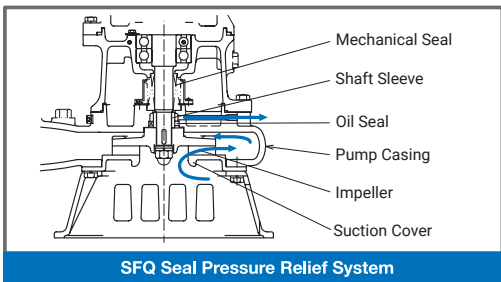

Dimension: Free Standing A / B / C

Dimension: Guide Rail Fitting (TO / TOS) D / E / F

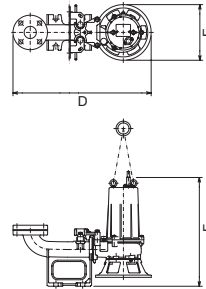
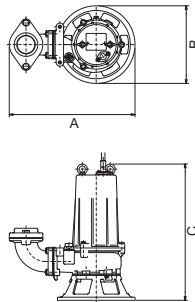

Three Phase Model	Motor Output (HP)	Rated Current (A)				*S.S. (RPM)	Discharge Size (in.)	Dimensions (in.)						Max. Solids Dia. (in.)
		208V	230V	460V	575V			Free Standing Models			TO Guide Rail Models			
								A	B	C	D	E	F	
50SFQ2.75	1	3.5	3.1	1.6	1.4	3600	2	9 15/16	7 11/16	15 11/16	N/A	N/A	N/A	0.24
80SFQ21.5	2	6.9	6.7	3.4	2.7	3600	3	12 15/16	8 11/16	19 1/16	N/A	N/A	N/A	0.24
80SFQ23.7	5	13.8	12.8	6.4	5.0	3600	3	14 1/8	10 1/8	21 5/16	N/A	N/A	N/A	0.59
100SFQ25.5	7.5	19.3	18.2	9.4	7.5	3600	4	25 3/8	14 3/16	33 1/4	37 3/16	14 3/16	35 7/8	0.79
100SFQ27.5	10	26.0	24.4	12.2	9.5	3600	4	25 3/8	14 3/16	33 1/4	37 3/16	14 3/16	35 7/8	0.79
100SFQ211	15	37.0	35.2	17.6	13.9	3600	4	25 3/8	14 3/16	35 1/8	37 3/16	14 3/16	37 13/16	0.91

\* Synchronous Speed

The **VANCS™ - OM, PU, PN, PSF and TM Series** submersible pump is designed for handling raw sewage, wastewater, as well as industrial and commercial sump pump applications. The VANCS™ pumps have a proven track record for offering long lifecycles in both continuous and intermittent sump applications. With the pump made of complete molded resin material and all other parts coming in contact with the pump liquid in either 304 Stainless Steel or Titanium.

# VANCS™



- Residential, commercial, industrial, effluent, wastewater and site drainage
- Chemical spill containment
- Raw water supply from rivers or lakes
- For TM Series: Titanium components increases corrosion resistance in a wide variety of applications. Ideal use for salt wastewater, site drainage and bilge pumps
- Automatic Operation (A) and Auto Alternating Operation (W) are available

## ✓ **VANCS™ Pumps: TOK Guide Rail Fitting System**

The TOK guide rail fitting system connects the pump to and from the piping easily just by lowering and hoisting the pump, allowing easy maintenance and inspection without the need to enter the sump.

Made of high-quality resin, the TOK is designed for lightweight, small to middle sized pumps. Rubber bellows attached to the guide hook are inverted to the duckfoot bend when the pump starts operating, and it seals by the pumping pressure. This eliminates leakage at the seal even if a lightweight pump is used in combination with the TOK.

The TOK is available in all motor output ranges of the PU, PN, and PSF Series.

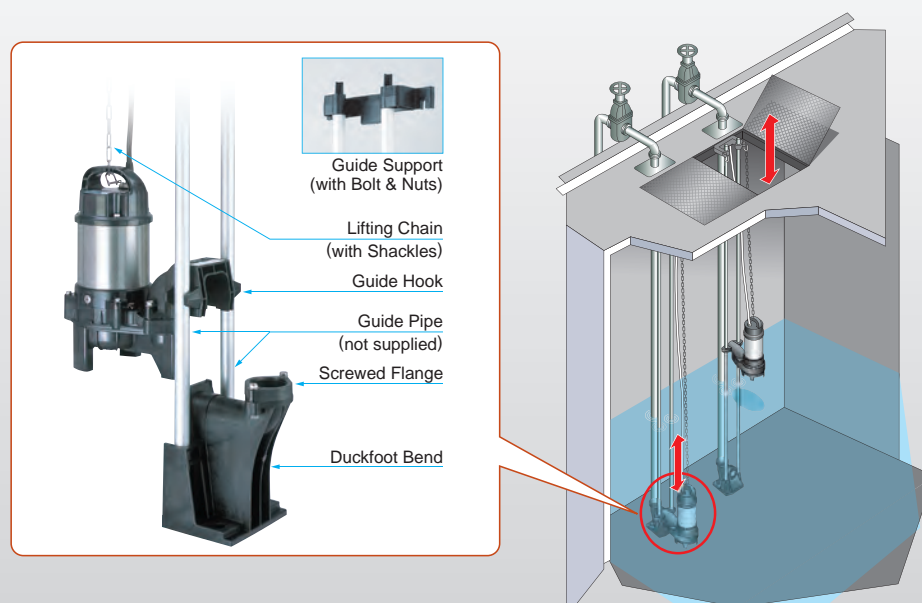



**Automatic & Auto-Alternation Models**

The VANCS™ pumps are available with automatic duplexing (suffix "A") capabilities eliminating the need for a duplexing control panel\*. The auto-alternating model has three floats and can be identified by the suffix "W". Refer to standard specifications for availability and model numbers. It is available in the same output range of the automatic pumps.

\*Note: Must be installed in accordance with all National or Local Electrical or Building Codes.



PNA: Automatic (A) Model

PUW: Auto-alternation (W) Model

**VANCS™ Pumps: Selection Table**

Category	Series	Discharge Size inch	Impeller	Model	Motor Output HP					
					1/5	1/3	1/2	1	2	3
Wastewater	OM	1.5	Vortex	Standard	[Orange arrow pointing right]					
				Automatic (A)	[Orange arrow pointing right]					
Wastewater	PN	2 – 3	Vortex	Standard	[Blue arrow pointing right]					
				Automatic (A)	[Blue arrow pointing right]					
				Auto-alternation (W)	[Blue arrow pointing right]					
Wastewater -High Head-	PSF	2 – 3	Closed	Standard	[Blue arrow pointing right]					
				Automatic (A)	[Blue arrow pointing right]					
				Auto-alternation (W)	[Blue arrow pointing right]					
Sewage	PU	2– 3	Vortex	Standard	[Blue arrow pointing right]					
				Automatic (A)	[Blue arrow pointing right]					
				Auto-alternation (W)	[Blue arrow pointing right]					
Seawater	TM	2 – 3	Vortex	Standard	[Blue arrow pointing right]					
				Automatic (A)	[Blue arrow pointing right]					

**VANCS™ Pumps: Type of Impeller**

**Vortex**

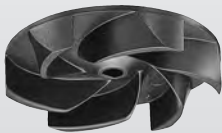

The vortex impeller is adopted in every series except for the PSF Series. Rotation of the impeller produces a whirling, centrifugal action between the impeller and the pump casing, and it moves the fluid through the pump. Being coupled with a wide pump casing, wastewater containing solid matters can be pumped out without obstruction.

**Closed**



The closed impeller is adopted in the PSF Series. The impeller is also referred to as shrouded impeller, as it has circular shrouds at both sides of the impeller vanes. Although the pump has a limited solids passage capability, it can be used for higher pumping head applications.

**VANCS™ Pumps Group Curves**

**OM Series**

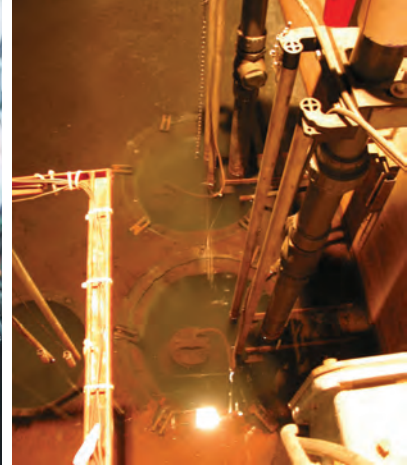
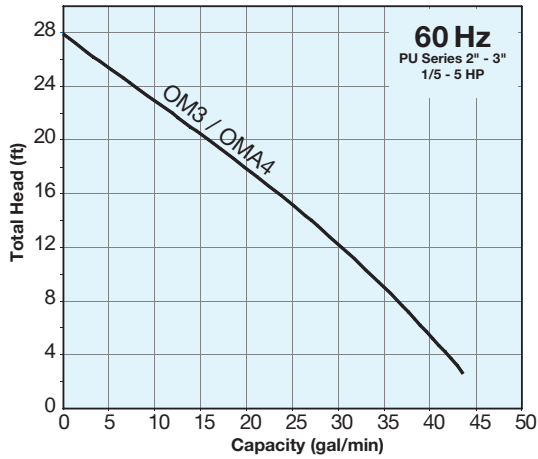

**PN Series**

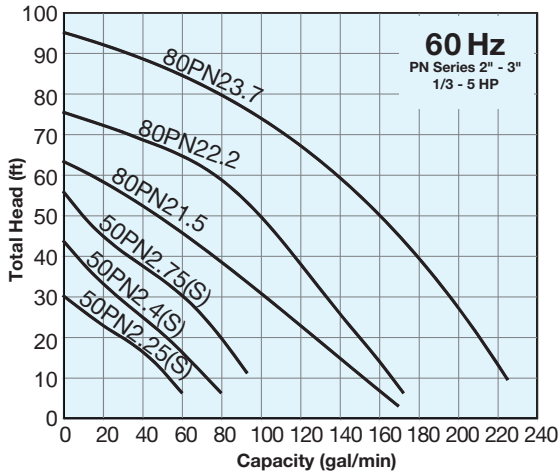

**PSF Series**

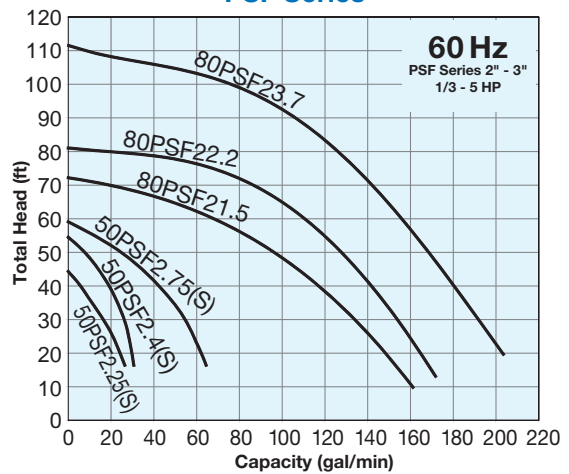

**PU Series**

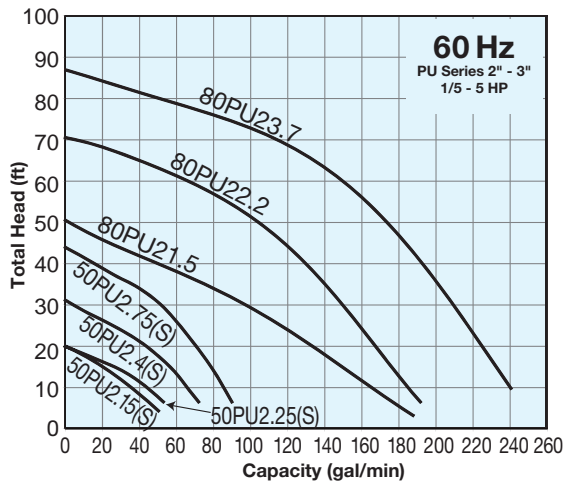

**TM Series**

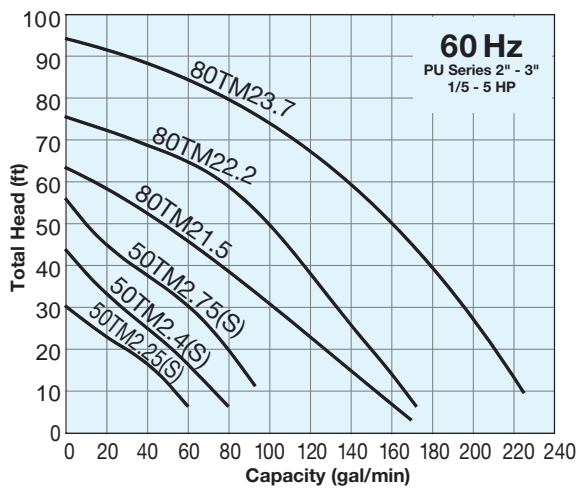



## CONTROL PANELS & MOISTURE DETECTOR

### ■ TS SERIES CONTROL PANELS

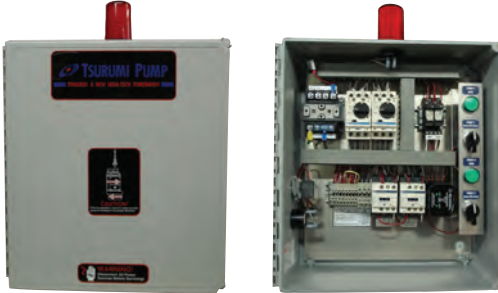

- Lockable – 4X Enclosures
- HOA Switch – Heavy Duty Oil Tight
- Terminal Block – For Field Wiring
- Pump Run Indicator – Heavy Duty Oil Tight
- Multi-Tap Control Transformer 208 / 230 / 460 VAC Operation
- Control Alarm Fuse
- Motor Protective Switch
- Adjustable Overload Protection
- IEC Rated Magnetic Contactor
- Horn Silence Switch – Heavy Duty Oil Tight
- Auto Reset Horn Silence
- Buzzer – 95db warble
- Red Alarm Beacon
- Includes three (3) Mechanical Float Switches & Pipe Clamp

### ■ SEAL MOISTURE PROBE

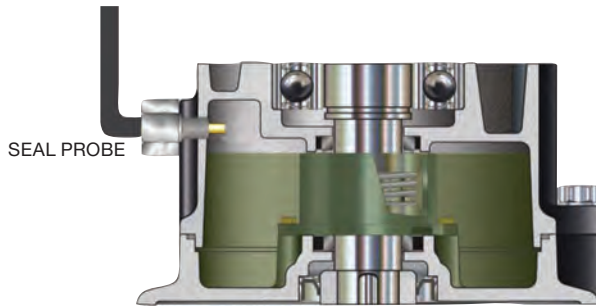

The **TSMP SEAL MOISTURE PROBE** is designed to detect moisture in the mechanical seal chamber, alerting customers of potential motor failure. The TSMP SEAL MOISTURE PROBE can be field installed on any new or existing Tsurumi pump models and connected to the control panel for the appropriate alarm or notification.

**Principle of Operation:**

- Sensor is installed through the oil port and directly into the mechanical seal chamber which contains an electrically non-conductive oil.
- The presence of water changes the chamber fluid mixture to a conductive condition and therefore completes the circuit which will result in a leakage indication on the control panel.

**Electrical Specification**

Sensor Type:	Conductive
Suggested Seal Fail Relay Voltage:	24 VAC
Required Wiring:	Single wire in separate sensor cable to be connected to seal leak relay in control panel by customer.

For Sales, Service, and Specifications, call:

**1 - 8 1 9 - 7 9 7 - 3 3 0 0**

Your Dealer



1156 avenue Lariviere  
Rouyn-Noranda, Québec, CANADA, J9X 4K8

Tel: 1-819-797-3300

[info@technosub.net](mailto:info@technosub.net)